

International Conference on Quantum Information (ICQI)

June 6-8 2011, Univ. of Ottawa, Ottawa, Canada

The 4th International Conference on Quantum Information will be held June 6-8, 2011 (with participants gathering Sunday, June 5) at the campus of the University of Ottawa, Ottawa, Canada.

Quantum information is an exciting, rapidly growing area of scientific interest and development, attracting cutting-edge theoretical and experimental research worldwide. Entanglement is a key resource for quantum information and quantum computing, whereas decoherence is the main adversary. Optical methods play a key role in many implementations of quantum information. The meeting will concentrate on entanglement, decoherence and optical methods, but contributions from all areas of quantum information science are welcome.

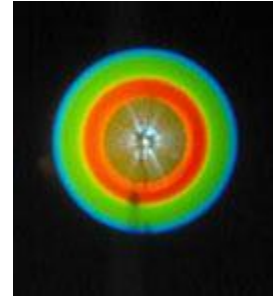

Photo courtesy of Alan Migdall and Alexander Sergienko

Plenary Speakers

- **Non-destructive Field Measurements and Quantum Feedback Experiments in Cavity Quantum Electrodynamics**, Serge Haroche, *Ecole Normale Supérieure, France*
- **Hyper-entanglement for Fun and Profit**, Paul Kwiat, *Univ. of Illinois at Urbana-Champaign, USA*
- **Engineered Dissipation for Quantum Information and Many Body Physics**, Peter Zoller, *Univ. Innsbruck, Austria*

View the list of [Invited Speakers](#)

View the conference program and plan your itinerary for the conference

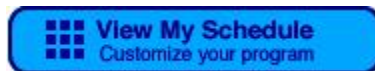

- Browse speakers and the agenda of sessions
- Browse sessions by type or day.
- Search by author, title, OCIS code and more.
- [Plan](#) and [print](#) your personal itinerary before coming to the conference

Chairs:

- Janos Bergou, *CUNY Hunter College, USA*, General Chair
- Saverio Pascazio, *Univ. of Bari, Italy*, General Chair
- Robert Boyd, *Univ. of Ottawa, Canada and Univ. of Rochester, USA*, Program Chair
- Alexander Sergienko, *Boston Univ., USA*, Program Chair

Sponsors:

OSA



uOttawa



UNIVERSITY of
ROCHESTER

International Conference on Quantum Information (ICQI)

June 6-8 2011, Univ. of Ottawa, Ottawa, Canada

Program

The International Conference on Quantum Information (ICQI) will concentrate on entanglement, decoherence and optical methods, but contributions from all areas of quantum information science are welcome. If you would like to be considered as a presenter, please review the topic categories below and the author/presenter information for submission guidelines.

A number of distinguished [invited speakers](#) have been invited to present at the meeting.

Poster Sessions

Poster sessions are an integral part of the technical program and offer a unique networking opportunity, where presenters can discuss their results one-to-one with interested parties. Each author is provided with a 4 ft. x 8 ft. (122 cm x 244 cm) board on which to display the summary and results of his or her paper.

Postdeadline Sessions

Postdeadline sessions are an opportunity to showcase the most late-breaking innovations in the field. Submissions are now open. Deadline is 11 May 2011, 12 pm noon EDT, 16:00 GMT. [View the submission guidelines and submit your paper.](#)

View the conference program and plan your itinerary for the conference



- Browse speakers and the agenda of sessions
- Browse sessions by type or day.
- Search by author, title, OCIS code and more.
- [Plan](#) and [print](#) your personal itinerary before coming to the conference

The welcoming reception will be Sunday evening, at 7pm in Tabaret Hall (Room 112).

All of the technical sessions will be in the SITE building.

The Tuesday evening reception will be at the Ottawa Convention Center.

About The International Conference on Quantum Information (ICQI)

The International Conference on Quantum Information (ICQI) will concentrate on entanglement, decoherence and optical methods, but contributions from all areas of quantum information science are welcome.

Papers are being considered in the following topic categories:

- Entanglement
- Decoherence
- Quantum imaging and lithography
- Quantum communication and cryptography, quantum channels, quantum repeaters
- Quantum control and error correction
- Algorithms, walks on graphs, spin chains, phase transitions, chaos, and localization
- Emerging topics: cluster states, adiabatic quantum computing, topological quantum computing
- Implementations: linear optics, cavity QED, ion traps, solid state, etc.

- Quantum state reconstruction, super-resolution
- Precision quantum measurements and metrology
- Storage and transfer of quantum information
- Novel practical quantum applications and technologies

The International Conference on Quantum Information (ICQI)

June 6-8, 2011
The University of Ottawa
Ottawa, Canada

Conference Program

**The conference organizers gratefully acknowledge support from
idQuantique, KBN Optics, the Newport Corporation, and
the Univ of Rochester.**

The International Conference on Quantum Information (ICQI)

June 6-8 2011, Univ. of Ottawa, Ottawa, Canada

Welcome to the 4th International Conference on Quantum Information held at the campus of the University of Ottawa, Ottawa, Canada.

Quantum information is an exciting, rapidly growing area of scientific interest and development, attracting cutting-edge theoretical and experimental research worldwide. Entanglement is a key resource for quantum information and quantum computing, whereas decoherence is the main adversary. Optical methods play a key role in many implementations of quantum information. The International Conference on Quantum Information (ICQI) will concentrate on entanglement, decoherence and optical methods, but also includes contributions from all areas of quantum information science.

Some of the topic categories that should be of interest are:

Entanglement

Decoherence

Quantum imaging and lithography

Quantum communication and cryptography, quantum channels, quantum repeaters

Quantum control and error correction

Algorithms, walks on graphs, spin chains, phase transitions, chaos, and localization

Emerging topics: cluster states, adiabatic quantum computing, topological quantum computing

Implementations: linear optics, cavity QED, ion traps, solid state, etc.

Quantum state reconstruction, super-resolution

Precision quantum measurements and metrology

Storage and transfer of quantum information

Novel practical quantum applications and technologies

Thank you for your participation in this exciting event, and we hope that you find the conference insightful and rewarding.

Janos Bergou, *CUNY Hunter College, USA*, **General Chair**

Saverio Pascazio, *Univ. of Bari, Italy*, **General Chair**

Robert Boyd, *Univ. of Ottawa, Canada, and Univ. of Rochester, USA*, **Program Chair**

Alexander Sergienko, *Boston Univ., USA*, **Program Chair**

Program Committee

General Chairs

Janos Bergou, *CUNY Hunter College, USA*

Saverio Pascazio, *Univ. of Bari, Italy*

Program Chairs

Robert Boyd, *Univ. of Ottawa, Canada, and Univ. of Rochester, USA*

Alexander Sergienko, *Boston Univ., USA*

Committee Members

Markus Aspelmeyer, *Univ. of Vienna, Austria*

Stephen Barnett, *Univ. of Strathclyde, UK*

Elisabeth Giacobino, *CNRS, France*

Gerd Leuchs, *Max Planck Inst. for the Science of Light, Univ. Erlangen-Nürnberg, Germany*

Norbert Lütkenhaus, *Inst. for Quantum Computing, Univ. of Waterloo, Canada*

Carlos Monken, *Univ. Federal de Minas Gerais, Brazil*

Kae Nemoto, *Natl. Inst. of Informatics, Japan*

Francesco Petruccione, *Univ. of KwaZulu-Natal, South Africa*

Barry Sanders, *Univ. of Calgary, Canada*

Andrew G. White, *Univ. of Queensland, Australia*

Registration

Registration will take place from 6 p.m. to 8 p.m. in Room 112 of Tabaret Hall on Sunday, June 5th, 2011, and from 7:30 a.m. to 8:30 a.m. in the SITE lobby on Monday, June 6th, 2011.

Welcome Reception

You are invited to attend a welcome reception, in Tabaret Hall, Room 112, at the University of Ottawa, on Sunday, June 5th, 2011. Please note that the conference registration table will open at 6:00 p.m., in the same location, and that the reception will be starting at 7:00 p.m. This reception will be the perfect opportunity to mingle with other conference attendees!

Banquet

You are invited to attend a dinner banquet, at the Ottawa Convention Center, on Tuesday June 7th, 2011. This banquet will be followed by a presentation by Dr. Anton Zeilinger, from the University of Vienna, Austria.

Lunch and Dinner

Lunches and dinners will be held in the SITE building throughout the conference.

Their schedule is as follow:

Monday, June 6	Lunch: 12:00 p.m. – 1:30 p.m. Dinner 6:30 p.m. – 7:30 p.m.
Tuesday, June 7	Lunch: 12:00 p.m. – 1:30 p.m. Dinner: Banquet at the Ottawa Convention Center
Wednesday, June 8	Lunch: Box lunch available at 12:30 p.m.

Coffee Breaks

Coffee breaks will be held throughout the conference.

The schedule is as follow:

Monday, June 6	10:00 a.m. – 10:30 a.m. 3:30 p.m. – 4:00 p.m.
Tuesday, June 7	10:00 a.m. – 10:30 a.m. 3:30 p.m. – 4:00 p.m.
Wednesday, June 8	10:00 a.m. – 10:30 p.m.

Post-conference Tours

If there is enough interest, there will be post-conference tours, led by University of Ottawa students, available on the afternoon of Wednesday June 8.

Plenary Speakers

Nondestructive Field Measurements and Quantum Feedback Experiments in Cavity Quantum Electrodynamics, *Serge Haroche, Ecole Normale Supérieure, France*

Hyper-entanglement for Fun and Profit, *Paul Kwiat, Univ. of Illinois at Urbana-Champaign, USA*

Engineered Dissipation for Quantum Information and Many Body Physics, *Peter Zoller, Univ. Innsbruck, Austria*

Post-banquet Presentation

"Some day, your honor, you may tax it", *Anton Zeilinger; Vienna Center for Quantum Science and Technology (VCQ, Faculty of Physics, Univ. of Vienna and Inst. of Quantum Optics and Quantum Information (IQOQI), Austrian Academy of Sciences.*

Invited Speakers

QMA1, Inducing Disallowed Two-Atom Transitions with Temporally Entangled Photons Revisited, *Marlan Scully^{1,2}; ¹Texas A&M Univ., USA; ²Princeton Univ., USA*

QMB1, Quantum Optical and Mechanical Interfaces for Spin Qubits, *Misha Lukin¹; ¹Harvard Univ., USA*

QMC1, Quantum Mechanics Meet Number Theory, *Sabine Wölk¹, Cornelia Feiler¹, Wolfgang Schleich¹; ¹Inst. of Quantum physics, Ulm Univ., Germany.*

QMC2, Detecting Entanglement with Non-Hermitian Operators, *Mark Hillery¹; ¹Physics, Hunter College, USA.*

QMC3, Ultimate Precision Limits for Parameter Estimation in Noisy Quantum-Enhanced Metrology, *Bruno M. Escher¹, Ruynet L. de Matos¹, Luiz Davidovich¹; ¹Instituto de Física, Universidade Federal do Rio de Janeiro, Brazil.*

QMD1, Integrated Quantum Photonics, *Jeremy O'Brien; Centre for Quantum Photonics, Univ. of Bristol, United Kingdom.*

QMD2, Transport of Spatially Entangled Qutrits Through a Photonic Crystal Fiber, Wolfgang Löffler¹, Eric R. Eliel¹, Han P. Woerdman¹, Tijmen G. Euser², Michael Scharrer², Philip Russell²; ¹*Leiden Inst. of Physics, Leiden Univ., Netherlands*; ²*Max Planck Inst. for the Science of Light, Germany*.

QMD3, Solid-state Cavity-QED in Polarization-degenerate Micropillar Cavities, Cristian Bonato¹, Jan Gudat¹, Evert van Nieuwenburg¹, Morten Bakker¹, Sumant Oemrawsingh¹, Susanna Thon², Hyochul Kim², Martin van Exter¹, Dirk Bouwmeester^{1,2}; ¹*Huygens Laboratory, Leiden Univ., Netherlands*; ²*Univ. of California Santa Barbara, USA*.

QME1, A Single Ion as the Mirror of an Optical Cavity, Hetet Gabriel¹, Lukas Slodicka¹, Nadia Roeck¹, Markus Hennrich¹, Rainer Blatt^{1,2}; ¹*University of Innsbruck, Austria*; ²*Inst. for Quantum Optics and Quantum Information, Austria*.

QME2, Optical Cooling of a 122-kHz Mechanical Resonator, Evan R. Jeffrey¹, Petro Sonin¹, Brian Pepper^{2,3}, Dustin Kleckner², Dirk Bouwmeester¹; ¹*Univ. of Leiden, Netherlands*; ²*Univ. of California, Santa Barbara, USA*; ³*Univ. of Chicago, USA*.

QME3, Decoherence of Optically Trapped Nanospheres in a Double-slit Experiment, Rainer Kaltenbaek¹, Oriol Romero-Isart², Markus Aspelmeyer¹; ¹*Vienna Center for Quantum Science and Technology, Faculty of Physics, Univ. of Vienna, Austria*; ²*Max-Planck Institut für Quantenoptik, Hans-Kopfermann-Strasse, Germany*.

QME4, Two-photon Speckles as a Probe of Spatial Entanglement, Henrique Di Lorenzo Pires¹, Wouter Peeters¹, Jasper Woudenberg¹, Martin van Exter¹; ¹*Huygens Laboratory, Leiden Univ., Netherlands*.

QMF1, Quantum Communications with Gaussian and non-Gaussian States of Light, Philippe Grangier¹; ¹*Institut d'Optique, France*.

QMF2, Quantum Key Distribution Coming of Age, Gerd Leuchs^{1,2}; ¹*Univ. Erlangen-Nuremberg, Germany*; ²*Max Planck Inst. for the Science of Light, Germany*.

QMF3, Improved Heralding Devices and Applications to Device Independent QKD, Norbert Lütkenhaus¹, David Pitkanen¹, Ricardo M. Wickert², Peter van Loock², Xiongfeng Ma¹; ¹*Inst. for Quantum Computing, Univ. of Waterloo, Canada*; ²*Max Planck Inst. for the Science of Light, Germany*.

QMF4, Continuous Variable Quantum Key Distribution: Security, Repeaters and Relativity, Timothy C. Ralph¹; ¹*Department of Physics, Univ. of Queensland, Australia*.

QMG1, Entanglement from Longitudinal and Scalar Photons, James Franson¹; ¹*Physics, Univ. of Maryland Baltimore County, USA.*

QMG2, Coherent Superpositions of Photon Additions and Subtractions for Noiseless Amplification and Advanced Quantum State Manipulation, Alessandro Zavatta^{1,2}, Massimiliano Locatelli², Constantina Polycarpou², Marco Bellini^{1,2}; ¹*National Inst. of Optics (INO-CNR), Italy*; ²*LENS and Department of Physics, Univ. of Florence, Italy.*

QMH1, Entanglement Generated by Dissipation, Christine Muschik¹, Hanna Krauter², Kasper Jensen², Wojciech Wasilewski², Jonas Meyer Petersen², Ignacio Cirac¹, Eugene Polzik²; ¹*Max-Planck-Institute for Quantum Optics, Germany*; ²*Niels Bohr Inst., Danish Quantum Optics Center QUANTOP, Denmark.*

QMH2, Open Quantum Random Walks and the Open Quantum Pascal Triangle, Francesco Petruccione^{1,2}, Ilya Sinayskiy^{1,2}; ¹*National Inst. for Theoretical Physics, South Africa*; ²*Quantum Research Group, Univ. of KwaZulu-Natal, South Africa.*

QTuA1, Quantum Information with Semiconductor Nanostructures, Elisabeth Giacobino¹; ¹*Laboratoire Kastler Brossel, Université Pierre et Marie Curie, ENS, CNRS, France.*

QTuB1, Electromagnetically Induced Transparency in Superconducting Circuits, Barry C. Sanders¹; ¹*Inst. for Quantum Information Science, Univ. of Calgary, Canada.*

QTuC1, Quantum Information Processing Via the Environment, Gershon Kurizki¹; ¹*Weizmann Inst of Science, Israel.*

QTuC2, Integration of Highly Probabilistic Sources into Optical Quantum Architectures, Kae Nemoto¹, Simon J. Devitt¹, Ashely M. Stephens¹, William J. Munro²; ¹*Principles of Informatics Research Division, National Inst. of Informatics, Japan*; ²*NTT Basic Research Laboratories, Japan.*

QTuD1, Quantum Optomechanics: QIPC and Quantum Foundations with Massive Mechanical Systems, Markus Aspelmeyer¹; ¹*Vienna Center for Quantum Science and Technology (VCQ), Faculty of Physics, Univ. of Vienna, Austria.*

QTuD2, Quantum Optical Control and Measurement in Optomechanics, Gerard J. Milburn¹, Adil Gangat¹; ¹*Mathematics and Physics, The Univ. of Queensland, Australia.*

QTuE1, Quantum Description of the Angular Coordinate and Angular Momentum, Stephen M. Barnett¹; ¹*Univ. of Strathclyde, United Kingdom.*

QTuE2, Spatial Light Modulators: Single-Photon, Spatial-Mode Analyzers, Miles Padgett¹, Jonathan Leach^{1,3}, Barry Jack¹, Mary J. Romero¹, Daniele Giovannini¹, Sonja Franke-Arnold¹, Stephen M. Barnett²; ¹*School of Physics and Astronomy, Univ. of Glasgow, United Kingdom*; ²*Department of Physics, Strathclyde Univ., United Kingdom*; ³*Department of Physics, Univ. of Ottawa, Canada*.

QTuF1, Propagation of an Entangled Two-Photon Beam Through the Turbulent Atmosphere, Carlos Monken¹, Marcelo V. Pereira¹, Luísa P. Filpi¹; ¹*Universidade Federal de Minas Gerais, Brazil*.

QTuF2, Exploring the Spatio-temporal Correlation of Twin Photons via Sum Frequency Generation, Alessandra Gatti^{1,2}, Enrico Brambilla², Ottavia Jedrkiewicz², Jean Luc Blanchet², Luigi A. Lugiato²; ¹*Istituto di Fotonica e Nanotecnologie, CNR, Italy*; ²*Physics and Mathematics, Insubria Univ., Italy*.

QTuG1, A Room Temperature Quantum Optical Memory, Mahdi Hosseini¹, Ben Sparkes¹, Geoff Campbell¹, Ben Buchler¹, Ping Koy Lam¹; ¹*The Australian National Univ., Australia*.

QTuG2, Broadband Waveguide Quantum Memory for Entangled Photons, Daniel Oblak¹, Erhan Saglamyurek¹, Neil Sinclair¹, Jeongwan Jin¹, Joshua A. Slater¹, Felix Bussieres², Mathew George³, Raimund Ricken³, Wolfgang Sohler³, Wolfgang Tittel¹; ¹*Department of Physics and Astronomy, Univ of California, San Diego, Canada*; ²*GAP-Optique, Univ. of Geneva, Switzerland*; ³*Department of Physics - Applied Physics, Univ. of Paderborn, Germany*.

QTuG3, A Single-atom Quantum Memory, Eden Figueroa¹, Holger Specht¹, Christian Nölleke¹, Andreas Reiserer¹, Manuel Uphoff¹, Stephan Ritter¹, Gerhard Rempe¹; ¹*Max Planck Inst. of Quantum Optics, Germany*.

QTuH1, General Cramer-Rao Bound for Parameter Estimation using Gaussian Multimode Quantum Resources, Claude Fabre¹, Olivier Pinel¹, Nicolas Treps¹, Julien Fadel², Daniel Braun³; ¹*Laboratoire Kastler Brossel, Univ. P.M. Curie, France*; ²*Institut de Physique de Rennes, Univ. Rennes 1, campus de Beaulieu, France*; ³*Laboratoire de Physique Théorique, Univ. Paul Sabatier, France*.

QTuH2, Polarization Correlations in Quantum Optics, Luis L. Sanchez-Soto^{1,5}, Andrei B. Klimov², Gunnar Bjork³, Jonas Soderholm^{3,5}, Ulrik Andersen^{4,5}, Christoph Marquardt⁵, Gerd Leuchs⁵; ¹*Optica, Universidad Complutense, Mexico*; ²*Fisica, Universidad de Guadalajara, Mexico*; ³*School of Communication and Information Technology, Royal Inst. of Technology (KTH), Sweden*; ⁴*Physics, Technical Univ., Denmark*; ⁵*Max Planck Institut für die Physik des Lichts, Germany*.

QTuH3, The Optical Parametric Oscillator: a Bright and Colorful Entangler, Antonio Coelho¹, Felipe Barbosa¹, Alencar Faria¹, Katuscia Cassemiro², Alessandro Villar^{2,3}, Marcelo Martinelli¹, Paulo Nussenzveig¹; ¹*Instituto de Fisica, Universidade de Sao Paulo, Brazil*; ²*Max Planck Inst. for the Science of Light, Germany*; ³*Inst. for Optics, Information and Photonics, Univ. of Erlangen-Nuremberg, Germany*.

QTuH4, On Quantum Efficiencies of Optical States, Dominic Berry¹, Alexander Lvovsky²; ¹*Inst. for Quantum Computing, Univ. of Waterloo, Canada*; ²*Department of Physics and Astronomy, Univ. of Calgary, Canada*.

QTuH5, Quantum Information Processing with Discrete and Continuous Variables, Ulrik Andersen¹, A. Tipsmark¹, A. Laghaout¹, R. Dong¹, M. Jezek¹, G. Björk¹; ¹*Technical Univ. of Denmark, Denmark*.

QWA1, Simulating Quantum Systems in Biology, Chemistry, and Physics, Andrew White¹; ¹*Univ. of Queensland, Australia*.

QWB1, Quantum Simulations with Trapped Ions, Rainer Blatt¹; ¹*Univ. of Innsbruck, Austria*.

QWC1, Recent Photonic Quantum Tests on Local Realism with Freedom of Choice and on the Nonclassicality of an Indivisible System., Anton Zeilinger; *Vienna Center for Quantum Science and Technology (VCQ, Faculty of Physics, Univ. of Vienna and Inst. of Quantum Optics and Quantum Information (IQOQI), Austrian Academy of Sciences*.

QWC2, Time-multiplexed Fiber Networks for Quantum Information Processing, Christine Silberhorn^{1,2}; ¹*Univ. of Paderborn, Integrated Quantum Optics, Germany*; ²*Max Planck Inst. for the Science of Light, Germany*.

QWD1, Demonstration of a Scalable Multi-photon Entanglement Source, Eli Megidish¹, Tomer Shacham¹, Assaf Halevy¹, Liat Dovrat¹, Hagai Eisenberg¹; ¹*Racah Inst. of Physics, Hebrew Univ. of Jerusalem, Israel*.

Agenda of Sessions

	Sunday, June 5 6:00 -- 8:00 p.m. ---Welcome Reception, Tabaret Hall					
	Monday, June 6		Tuesday, June 7		Wednesday, June 8	
8:15 a.m.	Welcome, <i>Lecture Hall 1</i>					
8:30 a.m.	Plenary: Peter Zoller, <i>Lecture Hall 1</i>		Plenary: Paul Kwiat, <i>Lecture Hall 1</i>		Plenary: Serge Haroche, <i>Lecture Hall 1</i>	
8:45 a.m.						
9:00 a.m.						
	Lecture Hall 1	Lecture Hall 2	Lecture Hall 1	Lecture Hall 2	Lecture Hall 1	Lecture Hall 2
9:15 a.m.	QMA1--Marlan Scully	QMB1--Misha Lukin	QTuA1-- Elisabeth Giacobino	QTuB1-- Barry Sanders	QWA1-- Andrew G. White	QWB1--Rainer Blatt
9:30 a.m.						
9:45 a.m.		QMB2-- Andreas Liapis	QTuA2-- Khabat Heshami	QTuB2-- Assaf Halevy	QWA2-- Viv Kendon	QWB2--Eden Figueroa
10:00 a.m.	Coffee, <i>SITE Lobby</i>		Coffee, <i>SITE Lobby</i>		Coffee, <i>SITE Lobby</i>	
10:15 a.m.						
10:30 a.m.	QMC1-- Wolfgang Schleich	QMD1--Jeremy O'Brien	QTuC1-- Gershon Kurizki	QTuD1-- Markus Aspelmeyer	QWC1-- Anton Zeilinger	QWD1--Eli Megidish
10:45 a.m.						
11:00 a.m.	QMC2--Mark Hillery	QMD2-- Wolfgang Löffler	QTuC2--Kae Nemoto	QTuD2-- Gerard Milburn	QWC2-- Christine Silberhorn	QWD2-- Bhaskar Roy Bardhan
11:15 a.m.						QWD3-- Svetlana Lukishova
11:30 a.m.	QMC3--Luiz Davidovich	QMD3-- Cristian Bonato	QTuC3-- Zdenek Hradil	QTuD3-- Roohollah Ghobadi	QWC3-- Paolo Facchi	QWD4-- Warren Grice
11:45 a.m.			QTuC4-- Thomas Stace	QTuD4--Erik Streed	QWC4-- Marco Piani	QWD5-- Giuseppe Patera
12:00 p.m.	Lunch, <i>SITE Building</i>		Lunch, <i>SITE Building</i>		QWC5-- Kevin Zielnicki	QWD6--Trent Graham
12:15 p.m.					QWC6-- Andreas Christ	
12:30 p.m.					Lunch, <i>SITE Building</i>	
12:45 p.m.						
1:00 p.m.						
1:15 p.m.						

	Monday, June 6		Tuesday, June 7		Wednesday, June 8
	Lecture Hall 1	Lecture Hall 2	Lecture Hall 1	Lecture Hall 2	
1:30 p.m.	QME1--Hetet Gabriel	QMF1--Philippe Grangier	QTuE1--Stephen Barnett	QTuF1--Carlos Monken	Tours of the Photonics Labs at the <i>Univ.</i> of Ottawa and of the Landmarks of the City of Ottawa will be available.
1:45 p.m.					
2:00 p.m.	QME2--Evan Jeffrey	QMF2--Gerd Leuchs	QTuE2--Miles Padgett	QTuF2--Alessandra Gatti	
2:15 p.m.					
2:30 p.m.	QME3--Rainer Kaltenbaek	QMF3--Norbert Lütkenhaus	QTuE3--Martin Lavery	QTuF3--Petros Zerom	
2:45 p.m.			QTuE4--Mehul Malik	QTuF4--David Simon	
3:00 p.m.	QME4--Henrique Di Lorenzo Pires	QMF4--Timothy C. Ralph	QTuE5--Heedeuk Shin	QTuF5--Jean-François Morizur	
3:15 p.m.			QTuE6--Taoufik Amri	QTuF6--Filippo Miatto	
3:30 p.m.	Coffee, <i>SITE Lobby</i>		Coffee, <i>SITE Lobby</i>		
3:45 p.m.					
4:00 p.m.	QMG1--Jim Franson	QMH1--Christine Muschik	QTuG1--Ping Koy Lam	QTuH1--Claude Fabre	
4:15 p.m.					
4:30 p.m.	QMG2--Marco Bellini	QMH2--Francesco Petruccione	QTuG2--Wolfgang Tittel	QTuH2--Luis L. Sanchez-Soto	
4:45 p.m.					
5:00 p.m.	PDPA1--Jonathan Leach	PDPB1--Sarah Croke	QTuG3--Eden Figueroa	QTuH3--Paulo Nussenzveig	
5:15 p.m.	PDPA2--Quentin Glorieux	PDPB2--Pavel Kolchin			
5:30 p.m.			QTuG4--Byoung Ham	QTuH4--Alexander Lvovsky	
5:45 p.m.			QTuG5--Khabat Heshami		
6:00 p.m.	Free time		QTuG6--Nathan Killoran	QTuH5--Ulrik Lund Andersen	
6:15 p.m.			QTuG7--Uzma Akram		

	Monday, June 6	Tuesday, June 7
6:30 p.m.	Dinner, <i>SITE Building</i>	Free time
6:45 p.m.		Banquet, <i>Ottawa Convention Center</i>
7:00 p.m.		
7:15 p.m.		
7:30 p.m.		
7:45 p.m.		
8:00 p.m.		
8:15 p.m.		
8:30 p.m.	Poster Session and Discussion, <i>SITE Lobby</i>	
8:45 p.m.		
9:00 p.m.		
9:15 p.m.		
9:30 p.m.		
9:45 p.m.		
10:00 p.m.		Anton Zeilinger, <i>Ottawa Convention Center</i>
10:15 p.m.		
10:30 p.m.		

Key to Agenda

Abstract #'s QMA1--QMH2 Monday Presentations
 Abstract #'s QTuA1--QTuH5 Tuesday Presentation
 Abstract #'s QWA1--QWD6 Wednesday Presentations
 Abstract #'s PDPA1 – PDPB2 Monday Postdeadlines
See Abstracts for Corresponding Presentation Details

Lecture Hall 1

QMA • Monday Session I

Monday, June 6, 2011

9:15 a.m. – 9:45 a.m.

QMA1 • 9:15 a.m. Invited

Inducing Disallowed Two-Atom Transitions with Temporally Entangled Photons Revisited, Marlan Scully^{1,2}; ¹*Texas A&M Univ., USA*; ²*Princeton Univ., USA*. Several years ago, Agarwal, Muthukrishnan and I published a PRL (93, 093002) on two-atom transitions with entangled photons. This paper has been the subject of spirited debate. The issues will be presented and resolved.

Lecture Hall 2

QMB • Monday Session II

Monday, June 6, 2011

9:15 a.m. – 10:00 a.m.

QMB1 • 9:15 a.m. Invited

Quantum Optical and Mechanical Interfaces for Spin Qubits, Misha Lukin¹; ¹*Harvard Univ., USA*. We will describe our recent theoretical and experimental work towards developing novel optical and mechanical quantum interfaces and quantum transducers for spin qubits in diamond. Novel applications of these techniques will be discussed.

QMB2 • 9:45 a.m.

Single-Photon Measurement of the Hartman Effect in Frustrated Total Internal Reflection, Andreas C. Liapis¹, George M. Gehring¹, Svetlana G. Lukishova^{1,2}, Robert Boyd^{1,3}; ¹*Inst. of Optics, Univ. of Rochester, USA*; ²*Laboratory for Laser Energetics, Univ. of Rochester, USA*; ³*Department of Physics, Univ. of Ottawa, Canada*. Using fourth-order interference, we have measured the single-photon tunneling delay in frustrated total internal reflection. The results are explained in terms of a dwell-time interpretation of the Hartman effect.

Lecture Hall 1

QMC • Monday Session III

Monday, June 6, 2011

10:30 a.m. – 12:00 p.m.

QMC1 • 10:30 a.m. Invited

Quantum Mechanics Meet Number Theory, Sabine Wölk¹, Cornelia Feiler¹, Wolfgang Schleich¹; ¹*Inst. of Quantum physics, Ulm Univ., Germany*. We suggest a way to determine the

Riemann zeta function with the help of quantum mechanics. Furthermore, we discuss the factoring abilities of Gauss sums and introduce a way to calculate them with the help of entanglement.

QMC2 • 11:00 a.m. Invited

Detecting entanglement with non-hermitian operators, Mark Hillery¹; ¹*Physics, Hunter College, USA*. We derive a number of entanglement conditions that make use of expectation values of non-hermitian operators. These are applied to study entanglement in systems of optical modes and in spin systems.

QMC3 • 11:30 a.m. Invited

Ultimate Precision Limits for Parameter Estimation in Noisy Quantum-Enhanced Metrology, Bruno M. Escher¹, Ruynet L. de Matos¹, Luiz Davidovich¹; ¹*Instituto de Física, Universidade Federal do Rio de Janeiro, Brazil*. We propose a general framework that yields useful lower bounds for ultimate limits of precision in parameter estimation for noisy systems, and describes the transition from the Heisenberg to the standard limit in optical interferometry.

Lecture Hall 2

QMD • Monday Session IV

Monday, June 6, 2011

10:30 a.m. – 12:00 p.m.

QMD1 • 10:30 a.m. Invited

Integrated Quantum Photonics, Jeremy O'Brien¹; ¹*Centre for Quantum Photonics, Univ. of Bristol, United Kingdom*. We will describe our latest results in applying integrated photonic circuits to photonic quantum information science and technology, including circuits for quantum logic, quantum algorithms and quantum walks, nonlinear and diamond single photon sources, and single photon detectors.

QMD2 • 11:00 a.m. Invited

Transport of Spatially Entangled Qutrits Through a Photonic Crystal Fiber, Wolfgang Löffler¹, Eric R. Eliel¹, Han P. Woerdman¹, Tijmen G. Euser², Michael Scharrer², Philip Russell²; ¹*Leiden Inst. of Physics, Leiden Univ., Netherlands*; ²*Max Planck Inst. for the Science of Light, Germany*. We report the successful transport of spatially entangled qutrits through a photonic crystal fiber, and demonstrate violation of a Bell inequality by the fiber-transported spatial qubit.

QMD3 • 11:30 a.m. Invited

Solid-state cavity-QED in polarization-degenerate micropillar cavities, Cristian Bonato¹, Jan Gudat¹, Evert van Nieuwenburg¹, Morten Bakker¹, Sumant Oemrawsingh¹, Susanna Thon², Hyochul Kim², Martin van Exter¹, Dirk Bouwmeester^{1,2}; ¹*Huygens Laboratory, Leiden Univ., Netherlands*; ²*Univ. of California Santa Barbara, USA*. We describe a technique to entangle a single

photon with an electron-spin in a quantum dot. We discuss the implementation in micropillars, showing how dot transitions can be tuned into resonance with polarization-degenerate cavities.

Lecture Hall 1

QME • Monday Session V

Monday, June 6, 2011

1:30 p.m. – 3:30 p.m.

QME1 • 1:30 p.m. Invited

A Single Ion as the Mirror of an Optical Cavity, Hetet Gabriel¹, Lukas Slodicka¹, Nadia Roeck¹, Markus Hennrich¹, Rainer Blatt^{1,2}; ¹*University of Innsbruck, Austria*; ²*Inst. for Quantum Optics and Quantum Information, Austria*. By tightly focussing a probe field onto an ion trapped in front of a distant mirror, we observe a modulation of the vacuum Rabi constant and demonstrate the operation of a single-ion as an optical mirror.

QME2 • 2:00 p.m. Invited

Optical Cooling of a 122-kHz Mechanical Resonator, Evan R. Jeffrey¹, Petro Sonin¹, Brian Pepper^{2,3}, Dustin Kleckner², Dirk Bouwmeester¹; ¹*Univ. of Leiden, Netherlands*; ²*Univ. of California, Santa Barbara, USA*; ³*Univ. of Chicago, USA*. We demonstrate radiation pressure cooling of the mechanical resonance of a novel opto-mechanical device from a temperature of 500-mK to <10 mK.

QME3 • 2:30 p.m. Invited

Decoherence of optically trapped nanospheres in a double-slit experiment, Rainer Kaltenbaek¹, Oriol Romero-Isart², Markus Aspelmeyer¹; ¹*Vienna Center for Quantum Science and Technology, Faculty of Physics, Univ. of Vienna, Austria*; ²*Max-Planck Institut für Quantenoptik, Hans-Kopfermann-Strasse, Germany*. Decoherence is a major limitation in the development of quantum technology. Here, we study decoherence in the context of a double-slit experiment aiming at fundamental tests of quantum theory using optically trapped dielectric nanospheres.

QME4 • 3:00 p.m. Invited

Two-photon speckles as a probe of spatial entanglement, Henrique Di Lorenzo Pires¹, Wouter Peeters¹, Jasper Woudenberg¹, Martin van Exter¹; ¹*Huygens Laboratory, Leiden Univ., Netherlands*. We experimentally study the statistics of spatially entangled photon pairs scattered by a disordered medium. Striking differences arise between highly entangled and almost separable states. The Schmidt number can be extracted from the speckle visibility.

Lecture Hall 2

QMF • Monday Session VI

Monday, June 6, 2011

1:30 p.m. – 3:30 p.m.

QMF1 • 1:30 p.m. Invited

Quantum Communications with Gaussian and non-Gaussian States of Light, Philippe Grangier¹; ¹*Institut d'Optique, France*. We describe various quantum communication protocols, using either Gaussian states (for continuous-variable quantum cryptography) or non-Gaussian states (for various applications, including non-deterministic noiseless amplification). Perspectives for deterministic vs non-deterministic quantum information processing will be discussed.

QMF2 • 2:00 p.m. Invited

Quantum Key Distribution Coming of Age, Gerd Leuchs^{1,2}; ¹*Univ. Erlangen-Nuremberg, Germany*; ²*Max Planck Inst. for the Science of Light, Germany*. Quantum hacking identifies imperfections in a practical quantum key distribution (QKD) implementation and the possibly-resulting attacks. This knowledge then defines the measures for improving the QKD device. The progress along this line is discussed.

QMF3 • 2:30 p.m. Invited

Improved Heralding Devices and Applications to Device Independent QKD, Norbert Lütkenhaus¹, David Pitkanen¹, Ricardo M. Wickert², Peter van Loock², Xiongfeng Ma¹; ¹*Inst. for Quantum Computing, Univ. of Waterloo, Canada*; ²*Max Planck Inst. for the Science of Light, Germany*. We propose an optical heralding scheme effectively implementing a quantum non-demolition measurement on single photons. It utilizes linear optics and down-conversion sources. The scheme allows to cut-out transmission loss from implementations of Device Independent QKD.

QMF4 • 3:00 p.m. Invited

Continuous Variable Quantum Key Distribution: Security, Repeaters and Relativity, Timothy C. Ralph¹; ¹*Department of Physics, Univ. of Queensland, Australia*. We prove security of a continuous variable quantum key distribution protocol using post selection against non-Gaussian eavesdropper attacks. We discuss CV repeater protocols based on noiseless amplification. We analyze CV QKD between non-inertial, relativistic observers.

Lecture Hall 1

QMG • Monday Session VII

Monday, June 6, 2011

4:00 p.m. – 5:00 p.m.

QMG1 • 4:00 p.m. Invited

Entanglement from longitudinal and scalar photons, James Franson¹; ¹*Physics, Univ. of Maryland Baltimore County, USA*. A covariant treatment of the electromagnetic field requires the introduction of longitudinal and scalar photons in addition to the usual transverse photons. It is shown that these additional photons can produce entanglement between distant atoms.

QMG2 • 4:30 p.m. Invited

Coherent superpositions of photon additions and subtractions for noiseless amplification and advanced quantum state manipulation, Alessandro Zavatta^{1,2}, Massimiliano Locatelli², Constantina Polycarpou², Marco Bellini^{1,2}; ¹*National Inst. of Optics (INO-CNR), Italy*; ²*LENS and Department of Physics, Univ. of Florence, Italy*. We experimentally realize coherent superpositions of single-photon additions and subtractions to perform a rich variety of complex state manipulations. Some of our recent results in this direction, including noiseless amplification, will be described.

Lecture Hall 2

QMH • Monday Session VIII

Monday, June 6, 2011

4:00 p.m. – 5:00 p.m.

QMH1 • 4:00 p.m. Invited

Entanglement Generated by Dissipation, Christine Muschik¹, Hanna Krauter², Kasper Jensen², Wojciech Wasilewski², Jonas Meyer Petersen², Ignacio Cirac¹, Eugene Polzik²; ¹*Max-Planck-Intitute for Quantumoptics, Germany*; ²*Niels Bohr Inst., Danish Quantum Optics Center QUANTOP, Denmark*. We present a robust method for generating entanglement by engineered dissipation. Two atomic ensembles are kept entangled for 0.04s. By combining the purely dissipative mechanism with measurements, steady state entanglement is observed for up to an hour.

QMH2 • 4:30 p.m. Invited

Open Quantum Random Walks and the Open Quantum Pascal Triangle, Francesco Petruccione^{1,2}, Ilya Sinayskiy^{1,2}; ¹*National Inst. for Theoretical Physics, South Africa*; ²*Quantum Research Group, Univ. of KwaZulu-Natal, South Africa*. Open Quantum Random Walks (OQRW) were introduced as completely positive maps on an appropriate Hilbert space. The OQRW on

the line is shown to give rise to a non-classical Pascal triangle, that stresses the rich dynamical behavior of these walks. Implications and further applications of the OQRW are discussed.

SITE Lobby

QMI • Poster Session I

Monday, June 6, 2011

7:30 p.m. – 10:00 p.m.

QMI1 • 7:30 p.m.

High Resolution Measurement of Polarization Mode Dispersion with Quantum

Interferometry, Andrew M. Fraine¹, Roman Egorov¹, Olga V. Minaeva^{3,1}, David S. Simon¹, Alexander V. Sergienko^{1,2}; ¹*Dept. of ECE/ENG, Boston Univ., USA*; ²*Dept. of Physics, Boston Univ., USA*; ³*Dept. of Biomedical Engineering, Boston Univ., USA*. A new quantum interferometric technique for measuring polarization mode dispersion with a higher precision than classical techniques is introduced. This approach simultaneously allows extracting chromatic and polarization mode dispersion parameters from a single optical setup.

QMI2 • 7:30 p.m.

Path Qubit Fusion for Photonic Cluster State Generation, Hee Su Park¹, Sang Min Lee¹, Jaeyoon Cho², Yoonsik Kang¹, Sang-Kyung Choi¹; ¹*KRISS, Republic of Korea*; ²*Imperial College, United Kingdom*. This work describes an experimental fusion operation of photonic path qubits. This new method helps to construct a more complex cluster state composed of single-photon two-qubit states that possess both polarization and path qubits.

QMI3 • 7:30 p.m.

Robust cluster state generation using ancilla-based systems, Viv Kendon¹, Katherine L. Brown¹, Clare Horsman^{2,3}, William J. Munro^{4,5}; ¹*Physics and Astronomy, Univ. of Leeds, United Kingdom*; ²*Department of Mathematics, Univ. of Bristol, United Kingdom*; ³*H. H. Wills Physics Laboratory, Univ. of Bristol, United Kingdom*; ⁴*National Inst. of Informatics, Japan*; ⁵*NTT Basic Research Laboratories, Japan*. We present a fully scalable ancilla-based method for generating cluster states using a qubus. By reusing the bus, we reduce the number of required operations by half, optimising the required resources.

QMI4 • 7:30 p.m.

Generation of Quantum States by Ergodic Maps, Kazuya Yuasa¹; ¹*Waseda Inst. for Advanced Study, Waseda Univ., Japan*. We present schemes for preparing quantum states, utilizing theorems on ergodicity of quantum channels. By repetition of measurements and feedbacks, quantum system is driven from an arbitrary state to the target state with probability 1.

QMI5 • 7:30 p.m.

Entanglement based frequency-time coding quantum key distribution, Bing Qi¹; ¹*Univ. of Toronto, Canada*. We extend the prepare-and-measure frequency-time coding quantum key distribution (FT-QKD) protocol to an entanglement based FT-QKD protocol. The latter can be implemented with a correlated frequency measurement scheme based on a time resolving single photon detector.

QMI6 • 7:30 p.m.

Bell-like inequality for spin-orbit separability of a laser beam, Antonio Z. Khoury¹, Carolina V. Borges¹, Malena Nor-Meyl¹, Jose Augusto O. Huguenin¹; ¹*Instituto de Fisica, Universidade Federal Fluminense, Brazil*. In analogy with Bell's inequality for two-qubit quantum states we propose an inequality criterion for the non-separability of the spin-orbit degrees of freedom of a laser beam. A definition of separable and non-separable spin-orbit modes is used. As the usual Bell's inequality can be violated for entangled two-qubit quantum states, we show both theoretically and experimentally that the proposed spin-orbit inequality criterion can be violated for non-separable modes.

QMI7 • 7:30 p.m.

QUANTUM MEASUREMENTS OF ATOMS USING CAVITY QED, Adetunmise C. Dada¹, Erika Andersson¹, Martin Jones², Viv Kendon², Mark S. Everitt^{3,2}; ¹*EPS, Heriot-Watt Univ., United Kingdom*; ²*School of Physics and Astronomy, Univ. of Leeds, United Kingdom*; ³*National Inst. of Informatics, Univ. of Leeds, Japan*. We propose schemes to realize two non-standard quantum measurements using cavity quantum electrodynamics (QED). Such measurements have only been realized on photons. A realization using atoms could be more easily scaled than existing realizations using photons.

QMI8 • 7:30 p.m.

Withdrawn

QMI9 • 7:30 p.m.

Withdrawn

QMI10 • 7:30 p.m.

Continuous variable hyperentanglement in a parametric oscillator, Antonio Z. Khoury¹, Bernardo Coutinho dos Santos¹, Kaled Dechoum¹; ¹*Instituto de Fisica, Universidade Federal Fluminense, Brazil*. We describe continuous variable hyperentanglement in polarization and orbital angular momentum modes of an optical parametric oscillator. The quantum stochastic equations for the multimode parametric interaction are derived and solved allowing for calculation of the quadrature noise spectra that characterize continuous variable entanglement. As a main result, we predict simultaneous entanglement between different combinations of amplitude and phase quadratures of the interacting modes.

QMI11 • 7:30 p.m.

A Michelson controlled-not gate with a single-lens astigmatic mode converter, Antonio Z. Khoury¹, Carlos Eduardo R. Souza¹; ¹*Instituto de Física, Universidade Federal Fluminense, Brazil*. Using a single lens design for a paraxial mode converter, we implement a controlled-not gate based on a Michelson interferometer in which the photon polarization acts as the control bit and the first order transverse mode as the target. We also build a parity sorter which can be useful for quantum information processing.

QMI12 • 7:30 p.m.

Maximally Discordant Mixed States of Two Qubits, Fernando Galve¹, Gian Luca Giorgi¹, Roberta Zambrini¹; ¹*IFISC (CSIC-UIB), Spain*. We identify the family of mixed states of two qubits that maximize the quantum discord for a given value of the classical correlations. They do not maximize entanglement and some of them are even separable.

QMI13 • 7:30 p.m.

Broadband spontaneous parametric fluorescence toward high-resolution quantum optical coherence tomography, Masayuki Okano^{1,2}, Ryo Okamoto^{1,2}, Akira Tanaka^{1,2}, Shanthi Subashchandran^{1,2}, Shutaro Ishida³, Norihiko Nishizawa³, Shigeki Takeuchi^{1,2}; ¹*Research Inst. for Electronic Science, Hokkaido Univ., Japan*; ²*The Inst. of Scientific and Industrial Research, Osaka Univ., Japan*; ³*Electrical Engineering and Computer Science, Nagoya Univ., Japan*. To realize high-resolution quantum optical coherence tomography, we generated broadband spontaneous parametric fluorescence from two nonlinear crystals. For comparison, we demonstrated optical coherence tomography using the super luminescence diode and will present recent our progresses.

QMI14 • 7:30 p.m.

Efficient Quantum Repeaters without Entanglement Purification, Laszlo Gyongyosi¹, Sandor Imre¹; ¹*Department of Telecommunications, Budapest Univ. of Technology and Economics, Hungary*. We present a fundamentally new idea, which enhances the efficiency of the quantum repeaters. It is possible to develop a quantum repeater with the elimination of the very inefficient and expensive purification process.

QMI15 • 7:30 p.m.

Weak Measurements Beyond the Aharonov-Albert-Vaidman Formalism, Shengjun Wu¹; ¹*Univ. of Science and Technology of China, China*. We extend the idea of weak measurements to the general case, provide a complete treatment and obtain results for both the regime when the PPS are almost orthogonal and the regime when they are exactly orthogonal.

QMI16 • 7:30 p.m.

Connectivity effects in the coined quantum walk search algorithm, Neil Lovett¹, Viv Kendon¹; ¹*Physics and Astronomy, Univ. of Leeds, United Kingdom*. We show numerically how the quantum walk search algorithm depends on both the spatial dimension and connectivity of the structure

being searched. We investigate this using a simple form of tunnelling to interpolate between lattices.

QMI17 • 7:30 p.m.

Towards a Short-range Free-space GHz-clocked Quantum Key Distribution System, María-José García-Martínez¹, Natalia Denisenko¹, Diego Soto¹, Verónica Fernández¹; ¹*Information Processing and Coding Group, Spanish National Research Council (CSIC), Spain*. A free-space quantum key distribution system that operates at a wavelength of 850 nm is presented. The system is designed to implement the B92 protocol at high transmission rates between two locations in urban areas.

QMI18 • 7:30 p.m.

Polarization-Spatial-Mode Entanglement of Photon Pairs, Enrique J. Galvez¹, Sean Nomoto¹, William Schubert¹, Matthew Novenster¹; ¹*Physics and Astronomy, Colgate Univ., USA*. We developed a scheme to prepare photon pairs in polarization-spatial-mode entangled states. This entailed sending polarization-entangled states to a polarization interferometer where diffractive-optical elements encode spatial modes onto the light.

QMI19 • 7:30 p.m.

The Security of SARG04 Protocol with An Untrusted Source, Hong Guo¹, Xiang Peng¹, Bingjie Xu¹; ¹*State Key Laboratory of Advanced Optical Communication Systems and Networks, School of Electronics Engineering and Computer Science, Peking Univ., China*. We investigate the security of SARG04 protocol with untrusted source. The secure key rate is derived given that several key parameters of the untrusted source are known. Further, a passive scheme is proposed to monitor the untrusted-source parameters.

QMI20 • 7:30 p.m.

Perfect transfer of multiple excitations in quantum networks, Thomas Brougham^{1,2}, Georgios M. Nikolopoulos³, Igor Jex²; ¹*Department of Physics, Univ. of Strathclyde, United Kingdom*; ²*Department of Physics, FNSPE, Czech Technical Inst. in Prague, Czech Republic*; ³*Inst. of Electronic Structure and Laser, FORTH Inst. - Hellas, Greece*. We show how one can design networks that perfectly transfer a state encoded on multiple interacting particles. Our approach is flexible enough to account for situations where particles are 'focused' onto the same site.

QMI21 • 7:30 p.m.

Fractional topological phase for entangled qudits, Antonio Z. Khoury¹, Luis Oxman¹; ¹*Instituto de Física, Universidade Federal Fluminense, Brazil*. We investigate the topological structure of entangled qudits under unitary local operations. Different sectors are identified in the evolution, and their geometrical and topological aspects are analyzed. The geometric phase is explicitly calculated in terms of the concurrence. As a main result, we predict a fractional

topological phase for cyclic evolutions in the multiply connected space of maximally entangled states.

QMI22 • 7:30 p.m.

Quantum teleportation in the spin-orbit variables of photon pairs, Antonio Z. Khoury¹, Perola Milman²; ¹*Instituto de Física, Universidade Federal Fluminense, Brazil*; ²*Laboratoire Matériaux et Phénomènes Quantiques, Université Paris Diderot, France*. We propose a polarization to orbital angular momentum teleportation scheme using entangled photon pairs generated by spontaneous parametric down conversion. By making a Bell measurement on the polarization and angular momentum parity of a single photon, we are able to perform teleportation from a discrete to a continuous variable.

QMI23 • 7:30 p.m.

Classical and Quantum Annealing in the Median of Three Satisfiability, Neuhaus Thomas¹; ¹*Supercomputing Center, Forschungszentrum Juelich, Germany*. We determine the classical and quantum complexities of a specific ensemble of three satisfiability problems. Standard, conventional adiabatic quantum computation fails to reduce the computational complexity to polynomial.

QMI24 • 7:30 p.m.

Bringing Entanglement to the High Temperature Limit, Fernando Galve¹, Leonardo A. Pachón², David Zueco³; ¹*IFISC (CSIC-UIB), Spain*; ²*Physics Department, Universidad Nacional de Colombia, Colombia*; ³*Condensed Matter Physics Department, Instituto de Ciencia de Materiales de Aragon, Spain*. Decoherence due to contact with a hot environment typically restricts quantum phenomena to the low temperature limit, $kBT/\hbar\omega \ll 1$ ($\hbar\omega$ is the typical energy of the system). Here we report the existence of a nonequilibrium state for two coupled, parametrically driven, dissipative harmonic oscillators which, contrary to generalized intuition, has stationary entanglement at high temperatures. This clarifies the role of temperature and could lighten the burden on quantum experiments requiring delicate precooling setups.

QMI25 • 7:30 p.m.

Distinguishability of Hyper-Entangled Bell States by Linear Evolution and Local Measurement, Neal Pomenti¹, Carl Philipp Gaebler^{1,2}, Theresa Lynn¹; ¹*Department of Physics, Harvey Mudd College, USA*; ²*Applied Physics and Applied Mathematics Department, The Fu Foundation School of Engineering and Applied Science, Columbia Univ., USA*. For two identical particles entangled in n two-state variables, we show that, of the 4^n hyper-entangled Bell states, $2^n - 1$ can be distinguished using linear evolution and local measurement. Our result generalizes previous results for $n=1,2$.

QMI26 • 7:30 p.m.

Scalable Multi Channel RF Pulse Generator for Quantum Computing Applications, Andrew Hammond¹, Steven Naboichek¹, Cosmos Wang¹, Liuping Chen¹, Anton Zavriyev¹, Keun Lee¹; ¹*MagiQ Technologies, USA*. DARPA and IARPA have funded MagiQ Technologies to develop a

novel scalable multi channel RF pulse generator for Quantum Computing applications. We will report on the project status and share our first experimental results.

QMI27 • 7:30 p.m.

Linearly independent states decomposition: quantum state discrimination, Luis Roa¹;

¹*Departamento de Física, Universidad de Concepción, Chile.* We put the pure-state decomposition mathematical property of a mixed state to a physical test. We begin by characterizing all the possible decompositions of a rank-two mixed state by means of the complex overlap between two involved states. The physical test proposes a scheme of quantum state recognition of one of the two linearly independent states which arise from the decomposition.

QMI28 • 7:30 p.m.

A Fast Measurement based fixed-point Quantum Search Algorithm, Ashish Mani¹, Patvardhan Chellapila¹; ¹*DEI, India.* This paper proposes a fast measurement based fixed-point quantum search algorithm which is faster than the existing similar algorithms. It is asymptotically as fast as the canonical quantum search algorithm and thus optimal up to a constant factor.

QMI29 • 7:30 p.m.

Fractional scaling of quantum walks on percolation lattices, Viv Kendon¹; ¹*Physics and Astronomy, Univ. of Leeds, United Kingdom.* Two-dimensional quantum walks on both bond and site percolation lattices show fractional scaling of the spreading with time, above around 85filled lattices the quantum walk is faster than classical random walks.

QMI30 • 7:30 p.m.

Withdrawn

QMI31 • 7:30 p.m.

The effect of electromagnetically induced transparency on an array of optical vortices, David Shwa¹, Nadav Katz¹; ¹*Racah Inst. of physics, Hebrew Univ., Israel.* An array of optical vortices is being used as a probe in an electromagnetically induced transparency experiment in warm Rubidium vapor. Scanning the two photon detuning reveals a change in the rotation angle and the distance between the vortices. We observe both positive (free-space like) enhanced rotation, and negative (contra free-space) rotation of the array.

QMI32 • 7:30 p.m.

Withdrawn

QMI33 • 7:30 p.m.

Entanglement Dynamics of Spin Ladder with Cyclic Interaction, Shiqun Zhu¹, Ying Yang¹, Yuping Xu¹; ¹*School of Physical Science and Technology, Soochow Univ., China.* In a long two-leg

spin ladder with cyclic interaction, the maximum entanglement can exist for quite long time. The entangled states can be stored and even can be "trapped" with high entanglement.

QMI34 • 7:30 p.m.

No Advantage to Entanglement in Bit Flip Parameter Estimation, David Collins¹, Michael Frey²; ¹*Physical and Environmental Sciences, Mesa State College, USA*; ²*Mathematics, Bucknell Univ., USA*. We consider optimal estimation of the parameter describing a bit-flip channel. Using the quantum Fisher information as a measure of accuracy, we show that entanglement offers no advantage for multiple channel.

QMI35 • 7:30 p.m.

Quantum resources for mapping non orthogonal states, Luis Roa¹; ¹*Departamento de Física, Universidad de Concepción, Chile*. We find the quantum discord and the entanglement required for performing a map between nonorthogonal states. We find that the protocol of changing the overlap of two nonorthogonal states can be performed successfully with or without entanglement, whereas the quantum discord is always required.

QMI36 • 7:30 p.m.

Single-qubit quantum gates using magnon-photon interaction, Pradeep Kumar Krishnamurthy¹; ¹*Electrical Engineering, Indian Inst. of Technology Kanpur, India*. We show that spin wave-optical interactions in YIG films can be used to realize single-qubit gates. Advantages include high-speed gating, ease of integration, and efficient operation in C-band.

QMI37 • 7:30 p.m.

Dynamics of entanglement transfer through multipartite dissipative systems, Carlos E. López¹; ¹*Physics, Universidad de Santiago de Chile, Chile*. We study the dynamics of entanglement transfer in a system composed of two initially correlated three-level atoms, each located in a cavity interacting with its own reservoir. Instead of tracing out reservoir modes to describe the dynamics using the master equation approach, we consider explicitly the dynamics of the reservoirs.

QMI38 • 7:30 p.m.

Spin entanglement length in a non-equilibrium superconductor, Llea N. Samuel¹, Roger Andrews¹; ¹*Physics, Univ. of the West Indies, Trinidad and Tobago*. The Keldysh formalism is used to analyze an energy-mode nonequilibrium superconductor. We find the entanglement length of the Cooper pairs contained in such a system to be of the order of 0.5×10^{-24} m.

QMI39 • 7:30 p.m.

Characterization process of emission sources of spin entangled pairs with several species, Francisco J. Delgado-Cepeda¹; ¹*Mathematics and Physics, Tecnológico de Monterrey, Mexico*. Normally, sources of entangled pairs generate several species of them. This work proposes a characterization algorithm for relatively general bipartite entangled states, generating several standard Bell states with controlled population as output.

QMI40 • 7:30 p.m.

Teleportation algorithm using two species of entangled pairs, Francisco J. Delgado-Cepeda¹; ¹*Mathematics and Physics, Tecnológico de Monterrey, Mexico*. Teleportation algorithm assumes specific Bell states as input, but actual sources typically generates more than one. This work presents a teleportation algorithm for a two Bell states mixture, including remaining distortion from previous control process.

QMI41 • 7:30 p.m.

Pure dephasing dynamics of two charge qubits, Wiem Ben Chouikha¹; ¹*Physique, Faculté des Sciences de Tunis, Tunisia*. We study the effect of pure dephasing on the entanglement of two charge qubits. The pure dephasing is due to the dephasing between two states of two electrons confined in double quantum dot (no relaxation). We evaluate the concurrence in order to quantify the evolution of the degree of entanglement. We show that the pure dephasing due to the interaction with acoustic phonons led to complete disentanglement.

QMI42 • 7:30 p.m.

An Efficient Protocol for Quantum Secure Dialogue With Authentication by Using Single Photons, Mosayeb Naseri¹; ¹*Islamic Azad Univ., Islamic Republic of Iran*. An efficient practical feasible protocol for quantum secure dialogue by using single photons is proposed. Comparing with the previous protocols, in the proposed protocol, no classical message has to exchanged during the decoding of the secret messages, so the present scheme is not only overcome the drawback "information leakage", it possesses the characters of security and maximum efficiency. The other highlight of our protocol is that, in this method one party is able to first read the message received from the other party before sending another message back in reply.

QMI43 • 7:30 p.m.

Exact Revival of the Bound Wave Function of Hydrogen for Arbitrary Quantum State, Matt Kalinski¹; ¹*Utah State Univ., USA*. We show that for the hydrogen atom for the state consisting of arbitrary but final number of the bound states total and exact full revival of the wavefunction exists for sufficiently long time of evolution.

QMI44 • 7:30 p.m. (Postdeadline Poster Presentation)

Quantum Discord and Quantum Entanglement's Attempts to Capture Quantum Correlations, Asma Al-Qasimi, Daniel F. James, *University of Toronto, Toronto, Ontario, Canada*. We study the newly discovered quantum correlation known as quantum discord numerically and compare it to the traditional entanglement. We also look at its relation with entropy to draw conclusions about its susceptibility to decoherence.

Lecture Hall 1

QTuA • Tuesday Session I

Tuesday, June 7, 2011

9:15 a.m. – 10:00 a.m.

QTuA1 • 9:15 a.m

Invited

Quantum information with semiconductor nanostructures, Elisabeth Giacobino¹; ¹*Laboratoire Kastler Brossel, Université Pierre et Marie Curie, ENS, CNRS, France*. Integrated optoelectronic devices based on exciton-polaritons are very promising for quantum information, since they allow quantum optical effects as well as spin control and spin switching. Moreover the quantum fluid properties of exciton polaritons indicate that they are good candidates for quantum simulation.

QTuA2 • 9:45 a.m

Precision requirements for spin-echo based quantum memories, Khabat Heshami¹, Nicolas Sangouard², Jiri Minar², Hugues de Riedmatten^{2,3}, Christoph Simon¹; ¹*Physics and Astronomy, Univ. of Calgary, Canada*; ²*Applied Physics, Univ. of Geneva, Switzerland*; ³*Inst. of Photonic Sciences, Mediterranean Technology Park, Spain*. We study effects of radio frequency control pulse imperfections, using both semi-classical and quantum-mechanical approaches. We achieve high efficiencies and low noise-to-signal ratios in the single-photon regime for realistic levels of control pulse precision.

Lecture Hall 2

QTuB • Tuesday Session II

Tuesday, June 7, 2011

9:15 a.m. – 10:00 a.m.

QTuB1 • 9:15 a.m

Invited

Electromagnetically induced transparency in superconducting circuits, Barry C. Sanders¹; ¹*Inst. for Quantum Information Science, Univ. of Calgary, Canada*. I discuss Autler-Townes splitting and electromagnetically induced transparency in superconducting circuits, how to incorporate lasing without inversion, and how to extend from one to several atoms.

QTuB2 • 9:45 a.m

Projection of Two Biphoton Qutrits onto a Maximally Entangled State, Assaf Halevy¹, Eli Megidish¹, Tomer Shacham¹, Liat Dovrat¹, Hagai Eisenberg¹; ¹*Racah Inst. of Physics, The Hebrew Univ. of Jerusalem, Israel*. We propose and demonstrate the projection of two quantum three state systems (qutrits) onto a maximally entangled state. The qutrits are represented by the polarization of biphotons - pairs of indistinguishable photons.

Lecture Hall 1

QTuC • Tuesday Session III

Tuesday, June 7, 2011

10:30 a.m. – 12:00 p.m.

QTuC1 • 10:30 a.m

Invited

Quantum Information Processing Via the Environment, Gershon Kurizki¹; ¹*Weizmann Inst of Science, Israel*. We present a universal comprehensive theory concerning the spontaneous emergence of quantum entanglement in multipartite systems immersed in thermal environments and the dynamical control aimed at its manipulation or protection.

QTuC2 • 11:00 a.m

Invited

Integration of highly probabilistic sources into optical quantum architectures, Kae Nemoto¹, Simon J. Devitt¹, Ashely M. Stephens¹, William J. Munro²; ¹*Principles of Informatics Research Division, National Inst. of Informatics, Japan*; ²*NTT Basic Research Laboratories, Japan*. We introduce a design for an optical computer constructed exclusively from a single quantum component. Unlike previous efforts we eliminate the need for on demand photon sources and detectors and replace them with the same device utilised to create photon/photon entanglement. This introduces highly probabilistic elements into the architecture while maintaining complete specificity of the structure and operation for a large scale computer.

QTuC3 • 11:30 a.m

Knowledge and ignorance in quantum state estimation, Zdenek Hradil¹, Jaroslav Rehacek¹; ¹*Palacky Univ., Czech Republic*. An overview of quantum reconstruction methods based on statistical interpretation is presented. In realistic experiments there is always a part of missing information yielding additional ambiguities. Robust estimation strategy based on maximum entropy and maximum likelihood estimation gives the optimal trade-off between ignorance and knowledge.

QTuC4 • 11:45 a.m

Loss Tolerance in Topological Quantum Codes, Thomas M. Stace¹; ¹*Physics, Univ. of Queensland, Australia*. Here we show that topological fault tolerant quantum computation (FTQC) schemes, which are known to have high error thresholds at the 1% level, are also extremely robust against losses. We demonstrate that these schemes tolerate loss rates up to 24.9%, determined by bond percolation on a cubic lattice.

Lecture Hall 2

QTuD • Tuesday Session IV

Tuesday, June 7, 2011

10:30 a.m. – 12:00 p.m.

QTuD1 • 10:30 a.m. Invited

Quantum Optomechanics: QIPC and quantum foundations with massive mechanical systems, Markus Aspelmeyer¹; ¹*Vienna Center for Quantum Science and Technology (VCQ), Faculty of Physics, Univ. of Vienna, Austria.* I will discuss how micro- and nano-optomechanical resonators are now becoming available as controlled quantum systems, with fascinating perspectives for both QIPC and quantum foundations.

QTuD2 • 11:00 a.m. Invited

Quantum Optical Control and Measurement in Optomechanics, Gerard J. Milburn¹, Adil Gangat¹; ¹*Mathematics and Physics, The Univ. of Queensland, Australia.* We present schemes that create entanglement between photons and phonons in an optomechanical system. One scheme enables single photon control and novel optomechanical nonlinearities. Another scheme enables quantum-limited readout of phonon jumps.

QTuD3 • 11:30 a.m.

Quantum Optomechanics in the Bistable Regime, Roohollah Ghobadi^{1,3}, Dustin Kleckner², Brian Pepper², Alireza Bahrampour³, Dirk Bouwmeester², Christoph Simon¹; ¹*physics, Inst. for Quantum Information Science, Canada;* ²*Physics, Univ. of California Santa Barbara, Santa Barbara, California 93106,, USA;* ³*Physics, Sharif Univ. of technology, Islamic Republic of Iran.* We have studied the simplest optomechanical system close to and in the bistable regime. We find that Optomechanical entanglement is particularly strong in this regime for large enough detuning. The robustness of entanglement against temperature is also studied.

QTuD4 • 11:45 a.m.

Scalable Imaging of Trapped Ions, Erik Streed¹, Andreas Jechow¹, Benjamin Norton¹, Matt Petrasianus¹, David Kielpinski¹; ¹*Centre for Quantum Dynamics, Griffith Univ., Australia.* Wavelength scale imaging of trapped Ytterbium ions was demonstrated using a microfabricated phase Fresnel lens. Near diffraction-limited spot sizes of below 440 nm (FWHM) were achieved, an important precursor to efficient single-mode coupling.

Lecture Hall 1

QTuE • Tuesday Session V

Tuesday, June 7, 2011

1:30 p.m. – 3:30 p.m.

QTuE1 • 1:30 p.m. Invited

Quantum Description of the Angular Coordinate and Angular Momentum, Stephen M. Barnett¹; ¹*Univ. of Strathclyde, United Kingdom.* We review the formulation of the operator for

rotation angles and the corresponding uncertainty relation. The orbital angular momentum of light allows us to test these ideas and also to explore angular entanglement.

QTuE2 • 2:00 p.m.

Invited

Spatial Light Modulators: Single-Photon, Spatial-Mode Analyzers, Miles Padgett¹, Jonathan Leach^{1,3}, Barry Jack¹, Mary J. Romero¹, Daniele Giovannini¹, Sonja Franke-Arnold¹, Stephen M. Barnett²; ¹*School of Physics and Astronomy, Univ. of Glasgow, United Kingdom*; ²*Department of Physics, Strathclyde Univ., United Kingdom*; ³*Department of Physics, Univ. of Ottawa, Canada*. Spatial Light Modulators (SLM) are pixellated display devices that can transform the phasefronts of the reflected light. Acting as programmable diffractive optical components they can transform between any two spatial modes and therefore form the basis of single-photon, spatial mode analyzers.

QTuE3 • 2:30 p.m.

Measuring the orbital angular moment of light with high optical efficiency, Martin P. Lavery¹, David J. Roberston², Gordon D. Love², Johannes Courtial¹, Gregorius C. Berhout^{3,4}, Miles Padgett¹; ¹*School of Physics and Astronomy, Univ. of Glasgow, United Kingdom*; ²*Centre for Advanced Instrumentation, Department of Physics, Durham Univ., United Kingdom*; ³*Huygens Laboratory, Leiden Univ., Netherlands*; ⁴*cosine Science & Computing BV, Netherlands*. We have produced custom refractive optical elements which transform orbital angular momentum states into linear direction states. This transformation allows for an efficient measurement of the orbital angular momentum content of an input light beam.

QTuE4 • 2:45 p.m.

High-Dimensional Quantum Key Distribution using Orbital Angular Momentum States of Light, Mehul Malik¹, Malcolm O'Sullivan¹, Robert Boyd^{1,2}; ¹*Optics, Univ. of Rochester, USA*; ²*Physics, Univ. of Ottawa, Canada*. We construct a QKD system that aims to send and receive information using Laguerre-Gauss (LG) modes in 8 dimensions. Our current data is limited to 4 dimensions by our detection system.

QTuE5 • 3:00 p.m.

Experimental demonstration of the optical centroid measurement method for spatial superresolution, Heedeuk Shin¹, Kam Wai C. Chan^{2,1}, Hye Jeong Chang^{3,1}, Robert Boyd^{1,4}; ¹*Inst. of Optics, Univ. of Rochester, USA*; ²*Rochester Optical Manufacturing Company, USA*; ³*Korean Intellectual Property Office, Republic of Korea*; ⁴*Department of Physics, Univ. of Ottawa, Canada*. We present an analysis based on combinatorics of the optical centroid measurement method, and we give experimental results showing enhanced spatial resolution identical to that of quantum lithography but with higher detection efficiency.

QTuE6 • 3:15 p.m.

Detecting “Schrödinger’s Cat” States of Light: Insights from the Retrodictive Approach,

Taoufik Amri^{1,2}, Julien Laurat^{1,3}, Claude Fabre^{1,3}; ¹*Laboratoire Kastler Brossel, France*; ²*Ecole Normale Supérieure, France*; ³*Université Pierre et Marie Curie, France*. We show how the retrodictive approach of quantum physics allows to study detectors of strongly non-classical states of light, such as “Schrödinger’s Cat” states of light, which can be useful for quantum metrology.

Lecture Hall 2

QTuF • Tuesday Session VI

Tuesday, June 7, 2011

1:30 p.m. – 3:30 p.m.

QTuF1 • 1:30 p.m.

Invited

Propagation of an Entangled Two-Photon Beam Through the Turbulent Atmosphere,

Carlos Monken¹, Marcelo V. Pereira¹, Luísa P. Filpi¹; ¹*Universidade Federal de Minas Gerais, Brazil*. We investigate the propagation of an entangled two-photon beam through the turbulent atmosphere simulated in a tabletop hot-air chamber. We show that in the weak turbulence regime (beam pointing fluctuation), under a suitable coordinate transformation, the fourth-order profile of the two-photon beam is less sensitive to turbulence than a laser beam with the same parameters.

QTuF2 • 2:00 p.m.

Invited

Exploring the spatio-temporal correlation of twin photons via sum frequency generation,

Alessandra Gatti^{1,2}, Enrico Brambilla², Ottavia Jedrkiewicz², Jean Luc Blanchet², Luigi A. Lugiato²; ¹*Istituto di Fotonica e Nanotecnologie, CNR, Italy*; ²*Physics and Mathematics, Insubria Univ., Italy*. We describe the X-shaped geometry, non-factorable in space and time, of the spatio-temporal correlation of biphotons and the temporal localization thereby achievable. We discuss a scheme where the X-correlation is revealed by the inverse process of sum frequency generation.

QTuF3 • 2:30 p.m.

Compressive Quantum Ghost Imaging,

Petros Zerom¹, Kam Wai C. Chan², John C. Howell³, Robert Boyd^{4,1}; ¹*Inst. of Optics, Univ. of Rochester, USA*; ²*Rochester Optical Manufacturing Company, USA*; ³*Department of Physics and Astronomy, Univ. of Rochester, USA*; ⁴*Department of Physics, Univ. of Ottawa, Canada*. We experimentally demonstrate high-resolution quantum ghost imaging at the single photon level using single-pixel (bucket) detectors and compressive sensing algorithms. Compared to quantum ghost imaging experiments employing a raster scan, we show both shortened data acquisition time and a more economical use of photons for low-light-level-imaging.

QTuF4 • 2:45 p.m.

Correlated Imaging with Aberration Cancellation, David S. Simon¹, Alexander V. Sergienko^{1,2}; ¹*Dept. of ECE/ENG, Boston Univ., USA*; ²*Dept. of Physics, Boston Univ., USA*. We discuss an apparatus capable of producing correlated-photon “ghost” images that cancel all object-induced aberrations in a particular plane and all odd-order aberrations induced by the image-forming optics.

QTuF5 • 3:00 p.m.

Spatial reshaping of a squeezed state of light, Jean-François Morizur^{1,2}, Pu Jian^{1,2}, Seiji Armstrong², Nicolas Treps¹, Jiri Janousek², Magnus Hsu³, Warwick Bowen³, Hans Bachor²; ¹*Laboratoire Kastler Brossel, Université Pierre et Marie Curie, France*; ²*Department of Quantum Science, Australian National Univ., Australia*; ³*School of Mathematics and Physics, Univ. of Queensland, Australia*. We present and characterize a Unitary Programmable Mode Converter, a device able to transfer squeezing efficiently from a spatial mode to another.

QTuF6 • 3:15 p.m.

Investigating the entanglement structure of down-converted photon pairs, Filippo Miatto¹, Stephen M. Barnett¹, Alison M. Yao¹, Miles Padgett², Barry Jack², Mary J. Romero²; ¹*Dept. of Physics, Univ. of Strathclyde, United Kingdom*; ²*Dept. of Physics, Univ. of Glasgow, United Kingdom*. We investigate the entanglement of photons produced by spontaneous parametric down-conversion. We analyse the down-converted state for any pump beam and for any detection modes in the complete Laguerre-Gauss basis.

Lecture Hall 1

QTuG • Tuesday Session VII

Tuesday, June 7, 2011

4:00 p.m. – 6:30 p.m.

QTuG1 • 4:00 p.m. Invited

A Room Temperature Quantum Optical Memory, Mahdi Hosseini¹, Ben Sparkes¹, Geoff Campbell¹, Ben Buchler¹, Ping Koy Lam¹; ¹*The Australian National Univ., Australia*. We demonstrate a quantum memory based on warm Rb atoms surpassing the no-cloning limit for optical coherent states down to single photon level. The state reconstruction reveals a fidelity up to 93% with an average efficiency of 78%.

QTuG2 • 4:30 p.m. Invited

Broadband Waveguide Quantum Memory for Entangled Photons, Daniel Oblak¹, Erhan Saglamyurek¹, Neil Sinclair¹, Jeongwan Jin¹, Joshua A. Slater¹, Felix Bussières², Mathew George³, Raimund Ricken³, Wolfgang Sohler³, Wolfgang Tittel¹; ¹*Department of Physics and Astronomy, Univ of California, San Diego, Canada*; ²*GAP-Optique, Univ. of Geneva, Switzerland*; ³*Department of Physics - Applied Physics, Univ. of Paderborn, Germany*. We report the reversible transfer of

photon-photon entanglement into entanglement between a photon and a collective atomic excitation in a thulium-doped lithium-niobate waveguide. We employ an Atomic-Frequency-Comb protocol yielding a 5 GHz acceptance bandwidth.

QTuG3 • 5:00 p.m.

Invited

A single-atom quantum memory, Eden Figueroa¹, Holger Specht¹, Christian Nölleke¹, Andreas Reiserer¹, Manuel Uphoff¹, Stephan Ritter¹, Gerhard Rempe¹; ¹*Max Planck Inst. of Quantum Optics, Germany*. We show the implementation of the most fundamental quantum memory by mapping arbitrary polarization states of light into and out of a single atom trapped inside an optical cavity.

QTuG4 • 5:30 p.m.

Spontaneous Emission-Free Photon Echoes for Quantum Memory Applications, Byoung S. Ham¹; ¹*school of electrical engineering, Inha Univ., Republic of Korea*. Using double rephasing and control deshelling, the inherent spontaneous emission noise is removed in photon echoes, where the spontaneous emission noise has been a major hurdle of direct use of photon echoes into quantum memories.

QTuG5 • 5:45 p.m.

Controllable-dipole quantum memory, Yang Han^{1,2}, Khabat Heshami¹, Arnaud Rispé^{1,3}, Erhan Saglamyurek¹, Neil Sinclair¹, Wolfgang Tittel¹, Christoph Simon¹; ¹*Physics and Astronomy, Univ. of Calgary, Canada*; ²*College of Science, National Univ. of Defense Technology, China*; ³*Department of Physics, École normale supérieure, France*. Here we present a new quantum memory scheme by directly controlling the transition dipole moment. We present analytical solution and propose the physical requirements by exploiting a magneto-dependent transition dipole moment in a Tm³:YAG crystal.

QTuG6 • 6:00 p.m.

Quantifying the strength of optical communication devices using entanglement measures, Nathan Killoran¹, Norbert Lütkenhaus¹; ¹*Inst. for Quantum Computing & Department of Physics and Astronomy, Univ. of Waterloo, Canada*. The quantum nature of an optical device can be verified using benchmarks based on entanglement verification. Without requiring additional resources, we show how to rigorously extend such benchmarks to quantify how well devices preserve entanglement.

QTuG7 • 6:15 p.m.

Cross cavity photon-phonon entanglement in a coupled optomechanical system, Uzma Akram¹, Gerard J. Milburn¹; ¹*Physics, Univ. of Queensland, Australia*. Two optomechanical cavities are coupled irreversibly and reversibly to each other. Cross-cavity photons and phonons can be entangled in the steady state of the collective system.

Lecture Hall 2

QTuH • Tuesday Session VIII

Tuesday, June 7, 2011

4:00 p.m. – 6:30 p.m.

QTuH1 • 4:00 p.m. Invited

General Cramer-Rao Bound for Parameter Estimation using Gaussian Multimode Quantum Resources, Claude Fabre¹, Olivier Pinel¹, Nicolas Treps¹, Julien Fadel², Daniel Braun³; ¹Laboratoire Kastler Brossel, Univ. P.M. Curie, France; ²Institut de Physique de Rennes, Univ. Rennes 1, campus de Beaulieu, France; ³Laboratoire de Physique Théorique, Univ. Paul Sabatier, France. We give the ultimate limit in parameter estimation that can be reached when the parameter is encoded in Gaussian multimode quantum light, whatever the estimation strategy and the detection technique, and show how to reach it.

QTuH2 • 4:30 p.m. Invited

Polarization correlations in quantum optics, Luis L. Sanchez-Soto^{1,5}, Andrei B. Klimov², Gunnar Bjork³, Jonas Soderholm^{3,5}, Ulrik Andersen^{4,5}, Christoph Marquardt⁵, Gerd Leuchs⁵; ¹Optica, Universidad Complutense, Mexico; ²Fisica, Universidad de Guadalajara, Mexico; ³School of Communication and Information Technology, Royal Inst. of Technology (KTH), Sweden; ⁴Physics, Technical Univ., Denmark; ⁵Max Planck Institut für die Physik des Lichts, Germany. The standard degree of polarization involves exclusively first-order moments of the Stokes variables. For quantum fields higher-order correlations are crucial and so a complete polarization characterization must involve a whole hierarchy of polarization degrees.

QTuH3 • 5:00 p.m. Invited

The Optical Parametric Oscillator: a Bright and Colorful Entangler, Antonio Coelho¹, Felipe Barbosa¹, Alencar Faria¹, Katuscia Cassemiro², Alessandro Villar^{2,3}, Marcelo Martinelli¹, Paulo Nussenzveig¹; ¹Instituto de Fisica, Universidade de Sao Paulo, Brazil; ²Max Planck Inst. for the Science of Light, Germany; ³Inst. for Optics, Information and Photonics, Univ. of Erlangen-Nuremberg, Germany. We describe the direct generation of tripartite three-color entanglement from a single optical parametric oscillator. The robustness of bipartite and tripartite entanglement against losses is also experimentally investigated.

QTuH4 • 5:30 p.m. Invited

On quantum efficiencies of optical states, Dominic Berry¹, Alexander Lvovsky²; ¹Inst. for Quantum Computing, Univ. of Waterloo, Canada; ²Department of Physics and Astronomy, Univ. of Calgary, Canada. We propose a universal measure of efficiency associated with a quantum-optical state and show that this efficiency cannot be improved by any linear-optical processing combined with destructive conditional measurements.

QTuH5 • 6:00 p.m.

Invited

Quantum Information Processing with discrete and continuous variables, Ulrik Andersen¹, A. Tipsmark¹, A. Laghaout¹, R. Dong¹, M. Jezek¹, G. Björk¹; ¹*Technical Univ. of Denmark, Denmark*.
By means of a hybrid detector we suggest and implement two protocols. We theoretically propose a feasible loophole-free violation of Bell's inequality and we experimentally realize a Hadamard transform of coherent superposition states.

Lecture Hall 1

QWA • Wednesday Session I

Wednesday, June 8, 2011

9:15 a.m. – 10:00 a.m.

QWA1 • 9:15 a.m

Invited

Simulating Quantum Systems in Biology, Chemistry, and Physics, Andrew White¹; ¹*Univ. of Queensland, Australia*. We use a photonic quantum computer to simulate the hydrogen molecule. This is the first experimental demonstration of efficient quantum chemistry, which promises to be a powerful new tool in biology, chemistry, and materials science.

QWA2 • 9:45 a.m

Quantum simulation and quantum analogue computation, Viv Kendon¹; ¹*Physics and Astronomy, Univ. of Leeds, United Kingdom*. Quantum simulation is expected to be one of the most important first applications of quantum computing. I motivate the use of continuous variable quantum computation (CVQC) for quantum simulation, and describe work investigating microwave frequency cavity QED systems as viable architectures for CVQC.

Lecture Hall 2

QWB • Wednesday Session II

Wednesday, June 8, 2011

9:15 a.m. – 10:00 a.m.

QWB1 • 9:15 a.m

Invited

Quantum Simulations with Trapped Ions, Rainer Blatt¹; ¹*Univ. of Innsbruck, Austria*. Quantum simulation makes use of a well controlled quantum system to make predictions on another quantum system under investigation. Here, we report on quantum simulations using trapped ions to investigate quantum relativistic effects and spin systems.

QWB2 • 9:45 a.m

A universal single-atom based quantum node, Eden Figueroa¹, Holger Specht¹, Martin Mücke¹, Christian Nölleke¹, Joerg Bochmann¹, Andreas Reiserer¹, Carolin Hahn¹, Manuel Uphoff¹, Andreas Neuzner¹, Stephan Ritter¹, Gerhard Rempe¹; ¹*Max Planck Inst. of Quantum Optics*,

Germany. We report our progress in the development of a universal node of a quantum network, capable of fully controlled photon generation, qubit storage and with intriguing perspectives towards the development of quantum gates.

Lecture Hall 1

QWC • Wednesday Session III

Wednesday, June 8, 2011

10:30 a.m. – 12:30 p.m.

QWC1 • 10:30 a.m

Invited

Recent Photonic Quantum Tests on Local Realism with Freedom of Choice and on the Nonclassicality of an Indivisible System., Anton Zeilinger; *Vienna Center for Quantum Science and Technology (VCQ, Faculty of Physics, Univ. of Vienna and Inst. of Quantum Optics and Quantum Information (IQOQI), Austrian Academy of Sciences.* In a Bell experiment the freedom-of-choice loophole was closed using random number generators space-like separated from the source. Another experiment on pairwise commuting observables of a three-state system rules out joint probability distributions.

QWC2 • 11:00 a.m

Invited

Time-Multiplexed Fiber Networks for Quantum Information Processing, Christine Silberhorn^{1,2}; ¹*Univ. of Paderborn, Integrated Quantum Optics, Germany*; ²*Max Planck Inst. for the Science of Light, Germany.* Time multiplexing in fiber networks has become a profitable tool for implementing quantum systems with multiple modes. We present recent progress for characterizing and manipulating pulsed quantum states of light in such architecture.

QWC3 • 11:30 a.m

Quantum Zeno Effect and Quantum Zeno Dynamics in Cavity Quantum Electrodynamics, Paolo Facchi¹, Saverio Pascazio¹, Jean-Michel Raimond¹, C. Sayrin¹, S. Gleyzes¹, Igor Dotsenko¹, Michel Brune¹, Serge Haroche¹; ¹*Universita di Bari, Italy.* We describe a cavity QED experiment on quantum Zeno effect with Rydberg atoms and a microwave superconducting cavity. We propose an implementation of quantum Zeno dynamics leading to promising methods for tailoring nonclassical field states.

QWC4 • 11:45 a.m

Linear-Optics Realization of Channels for Single-Photon Multimode Qudits, Marco Piani¹, David Pitkanen¹, Rainer Kaltenbaek^{1,2}, Norbert Lütkenhaus¹; ¹*Physics and Astronomy, Universtiy*

of Waterloo, Canada; ²Vienna Center for Quantum Science and Technology, Univ. of Vienna, Austria. We study the stochastic realization of an arbitrary quantum channel on a single-photon multimode qudit under a set of assumptions that make our scheme amenable to experimental implementation by linear optics.

QWC5 • 12:00 p.m.

Engineering an Unentangled Downconversion Source, Kevin Zielnicki¹, Radhika Rangarajan¹, Paul G. Kwiat¹; ¹Physics, Univ. of Illinois at Urbana-Champaign, USA. Spontaneous parametric downconversion is an important process for providing pairs of photons for quantum optics. We discuss a scheme for eliminating undesired inter-photon correlations inherent in this process, and an efficient characterization of spectral correlations.

QWC6 • 12:15 p.m.

Multimode ultrafast information coding: State generation, transmission and loss evaluation, Andreas Christ^{1,2}, Cosmo Lupo³, Christine Silberhorn^{1,2}; ¹Applied Physics, Univ. of Paderborn, Germany; ²IQO-Group, Max Planck Inst. for the Science of Light, Germany; ³Dipartimento di Fisica, Universit di Camerino, Italy. We introduce multiplexed information coding in quantum channels, using waveguided PDC sources emitting the required quantum states. We analyze the obtained channel capacities, present a significant gain over single-mode coding, and enhanced loss resilience.

Lecture Hall 2

QWD • Wednesday Session IV

Wednesday, June 8, 2011

10:30 a.m. – 12:15 p.m.

QWD1 • 10:30 a.m

Invited

Demonstration of a Scalable Multi-photon Entanglement Source, Eli Megidish¹, Tomer Shacham¹, Assaf Halevy¹, Liat Dovrat¹, Hagai Eisenberg¹; ¹Racah Inst. of Physics, Hebrew Univ. of Jerusalem, Israel. We experimentally demonstrate a novel multiphoton entangling system that in principle can entangle any number of photons. Spatial degrees of freedom are replaced by temporal degrees of freedom. Four and six photon states are presented.

QWD2 • 11:00 a.m

Dynamical Decoupling in Optical Fibers: Preserving Polarization Qubits from Birefringent Dephasing, Bhaskar Roy Bardhan¹, Manish K. Gupta¹, Petr M. Anisimov¹, Jonathan P. Dowling¹; ¹Louisiana State Univ., USA. We study preservation of polarization qubits in the polarization-maintaining fibers enhanced with dynamical decoupling sequence implemented in space instead of time. Such fibers maintain high fidelity with scalable waveplate implementations for specific input states.

QWD3 • 11:15 a.m

Room-Temperature Single-Photon Sources with Definite Circular and Linear Polarizations, Svetlana G. Lukishova¹, Luke Bissell¹, Justin Winkler¹; ¹*The Inst. of Optics, Univ. of Rochester, USA*. Experimental results of two room-temperature, robust and efficient single photon sources with definite circular and linear polarization using single-emitter fluorescence in cholesteric and nematic liquid crystal hosts are discussed.

QWD4 • 11:30 a.m

Bright Photon Pair Source with High Spectral and Spatial Purity, Warren Grice^{1,2}, Ryan Bennink¹, Philip Evans¹, Travis Humble¹, Jason Schaake²; ¹*Computational Sciences and Engineering, Oak Ridge National Lab, USA*; ²*Department of Physics and Astronomy, Univ. of Tennessee, USA*. We report the design and experimental characterization of a down-conversion source optimized for high spectral and spatial purity. Spatial and spectral entanglement are minimized through careful control of pump properties and material parameters.

QWD5 • 11:45 a.m

Spatial structure of multipartite entanglement in parametric down-conversion with structured pump, Giuseppe Patera¹, Mikhail I. Kolobov¹; ¹*Laboratoire PhLAM, Université Lille 1, France*. We introduce the concept of spatiotemporal multipartite entanglement and study its space-time properties in terms of coherence time and the coherence area as functions of the number of entangled “parties” in the system.

QWD6 • 12:00 p.m.

Quantum Process Tomography by Direct Characterization of Quantum Dynamics Using Hyperentangled Photons, Trent M. Graham¹, Julio T. Barreiro², Paul G. Kwiat¹; ¹*Univ. of Illinois at Urbana-Champaign, USA*; ²*Physics, Univ. of Innsbruck, Austria*. We present the first experimental results using photons entangled in multiple degrees of freedom to efficiently characterize various single-photon processes by Direct Characterization of Quantum Dynamics (DCQD), with the fewest possible number of measurements.

Postdeadline Papers*

Lecture Hall 1

PDPA • Postdeadline Session I

Monday, June 6, 2011

5:00 p.m. – 5:30 p.m

PDPA1 • 5:00 p.m.

Measuring Correlated Photon Pairs with an EMCCD Camera, Jonathan Leach¹, Ryan Warburton⁴, Sangeeta Murugkar¹, Matt Edgar³, Miles Padgett³, Robert Boyd^{1,2}, ¹*University of Ottawa, Canada*; ²*University of Rochester, USA*, ³*University of Glasgow, UK*, ⁴*Heriot Watt University, UK*, The multiple pixels and high quantum efficiency of EMCCD cameras make them an attractive technology for quantum optics. We use such a camera to measure correlations present in the two-photon field generated by parametric down-conversion.

PDPA2 • 5:15 p.m.

Four-wave-mixing in Hot Atomic Vapor for Spatially Multimode Squeezed Light Generation, Quentin Glorieux, Jeremy Clark, Neil Corzo-Trejo, Zhifan Zhou, Ryan Glasser, Alberto Marino, Ulrich Vogl, Paul Lett, *Laser Cooling Group, NIST, USA*. Four-wave-mixing in hot atomic vapor is a versatile tool for spatially multimode squeezed light generation. We demonstrate multimode behavior for different pump-probe configurations producing either single beam squeezing or twin beams.

Lecture Hall 2

PDPB • Postdeadline Session II

Monday, June 6, 2011

5:00 p.m. – 5:30 p.m

PDPB1 • 5:00 p.m.

Longer Baseline Telescope Arrays Using Quantum Repeaters, Daniel Gottesman¹, Thomas Jennewein², Sarah Croke¹, Latham Boyle¹, ¹*Perimeter Institute for Theoretical Physics, Waterloo, Ontario, Canada*, ²*Institute for Quantum Computing and Department of Physics and Astronomy, University of Waterloo, Waterloo, Ontario, Canada*. Interferometry among telescope arrays has become a standard technique in astronomy. We discuss using quantum repeaters to increase the baseline length, and therefore resolving power, of telescope arrays at optical observing frequencies.

PDPB2 • 5:15 p.m.

Strong Interaction of Distinct Single Photons via a Single Atom in a Waveguide, Pavel Kolchin, Rupert F. Oulton, Xiang Zhang, *University of California at Berkeley, Berkeley, CA, USA*. We propose a waveguide QED scheme where distinct single photons interact strongly at a ladder or V-type atom. When both atomic transitions are strongly coupled to the waveguide, photon tunneling and a π phase shift is induced by another distinct photon.

***Postdeadline papers are published at the end of the program book, after the Key to Authors and Presiders. Cite these papers with ISBN # 978-1-55752-928-2.**

Key to Authors and Presiders
(**Bold** denotes Presider or Presenting Author)

A

Akram, Uzma-**QTuG7**
Almutairi, Khulud-QMI9
Al-Qasimi, Asma-**QMI44**
Amri, Taoufik-**QTuE6**
Andersen, Ulrik-QTuH2, **QTuH5**
Andersson, Erika-QMI7
Andrews, Roger-QMI38
Anisimov, Petr M-QWD2
Armstrong, Seiji-QTuF5
Aspelmeyer, Markus-QME3, **QTuD1**

B

Bachor, Hans-QTuF5
Bahrapour, Alireza-QTuD3
Bakker, Morten-QMD3
Barbosa, Felipe-QTuH3
Barnett, Stephen Mark-**QTuE1**, QTuE2, QTuF6
Barreiro, Julio T-QWD6
Bellini, Marco-**QMG2**
Ben Chouikha, Wiem-**QMI41**
Bennink, Ryan-QWD4
Berhout, Gregorius C-QTuE3
Berry, Dominic-QTuH4
Bissell, Luke-QWD3
Bjork, Gunnar-QTuH2
Björk, G.-QTuH5
Blanchet, Jean Luc-QTuF2
Blatt, Rainer-QME1, **QWB1**
Bochmann, Joerg-QWB2
Bonato, Cristian-**QMD3**
Borges, Carolina V-QMI6
Bouwmeester, Dirk-QMD3, QME2, QTuD3
Bowen, Warwick-QTuF5
Boyd, Robert-QMB2, QTuE4, QTuE5, QTuF3, PDPA1

Boyle, Latham—PDPB1
Brambilla, Enrico-QTuF2
Braun, Daniel-QTuH1
Brougham, Thomas-**QMI20**
Brown, Katherine L-QMI3
Brune, Michel-QWC3
Buchler, Ben-QTuG1
Bussieres, Felix-QTuG2

C

Campbell, Geoff-QTuG1
Casemiro, Katuscia-QTuH3
Chan, Kam Wai C-QTuE5, QTuF3
Chang, Hye Jeong-QTuE5
Chellapila, Patvardhan-QMI28
Chen, Liuping-QMI26
Chen, Pochung-QMI30
Cho, Jaeyoon-QMI2
Choi, Sang-Kyung-QMI2
Christ, Andreas-**QWC6**
Cirac, Ignacio-QMH1
Clark, Jeremy—PDPA2
Coelho, Antonio-QTuH3
Collins, David-**QMI34**
Corzo-Trejo, Neil—PDPA2
Courtial, Johannes-QTuE3
Coutinho dos Santos, Bernardo-QMI10
Croke, Sarah—**PDPB1**

D

Dada, Adetunmise Charles-**QMI7**
Davidovich, Luiz-**QMC3**
Dechoum, Kaled-QMI10
Delgado-Cepeda, Francisco Javier-**QMI39**, **QMI40**
Denisenko, Natalia-QMI17
Devitt, Simon J-QTuC2

de Matos, Ruynet L, Filho-QMC3
de Riedmatten, Hugues-QTuA2
Di Lorenzo Pires, Henrique-QME4
Dong, R.-QTuH5
Dotsenko, Igor-QWC3
Dovrat, Liat-QTuB2, QWD1
Dowling, Jonathan P-QWD2

E

Edgar, Matt—PDPA1
Egorov, Roman-QMI1
Eisenberg, Hagai-QTuB2, QWD1
Eliel, Eric R-QMD2
Escher, Bruno M-QMC3
Euser, Tijmen G-QMD2
Evans, Philip-QWD4
Everitt, Mark S-QMI7

F

Fabre, Claude-QTuE6, **QTuH1**
Facchi, Paolo-QWC3
Fade, Julien-QTuH1
Faria, Alencar-QTuH3
Feiler, Cornelia-QMC1
Fernández, Verónica-QMI17
Ficek, Zbigniew-QMI9
Figueroa, Eden-QTuG3, **QWB2**
Filpi, Luísa P-QTuF1
Fraine, Andrew M-QMI1
Franke-Arnold, Sonja-QTuE2
Franson, James-QMG1
Frey, Michael-QMI34

G

Gabriel, Hetet-QME1
Gaebler, Carl Philipp-QMI25
Galve, Fernando-QMI12, **QMI24**
Galvez, Enrique J-QMI18
Gangat, Adil-QTuD2
García-Martínez, María-José-QMI17
Gatti, Alessandra-QTuF2
Gehring, George M-QMB2
George, Mathew-QTuG2

Ghobadi, Roohollah-**QTuD3**
Giacobino, Elisabeth-**QTuA1**
Giorgi, Gian Luca-QMI12
Giovannini, Daniele-QTuE2
Glasser, Ryan—PDPA2
Gleyzes, S.-QWC3
Glorieux, Quentin—**PDPA2**
Gottesman, Daniel—PDPB1
Graham, Trent M-QWD6
Grangier, Philippe-QMF1
Grice, Warren-QWD4
Gudat, Jan-QMD3
Guo, Hong-QMI19
Gupta, Manish K-QWD2
Gyongyosi, Laszlo-QMI14

H

Hahn, Carolin-QWB2
Halevy, Assaf-**QTuB2**, QWD1
Ham, Byoung S.-**QTuG4**
Hammond, Andrew-QMI26
Han, Yang-QTuG5
Haroche, Serge-QWC3
Henrich, Markus-QME1
Heshami, Khabat-**QTuA2**, **QTuG5**
Hillery, Mark-QMC2
Horsman, Clare-QMI3
Hosseini, Mahdi-QTuG1
Howell, John C-QTuF3
Hradil, Zdenek-**QTuC3**
Hsu, Magnus-QTuF5
Huguenin, Jose Augusto O-QMI6
Humble, Travis-QWD4

I

Imre, Sandor-QMI14
Ishida, Shutaro-QMI13

J

Jack, Barry-QTuE2, QTuF6
James, Daniel F.—QMI44
Janousek, Jiri-QTuF5
Jechow, Andreas-QTuD4

Jedrkiewicz, Ottavia-QTuF2
Jeffrey, Evan R-QME2
Jennewein, Thomas—PDPB1
Jensen, Kasper-QMH1
Jex, Igor-QMI20
Jezek, M.-QTuH5
Jian, Pu-QTuF5
Jin, Jeongwan-QTuG2
Jones, Martin-QMI7

K

Kalinski, Matt-QMI43
Kaltenbaek, Rainer-QME3, QWC4
Kang, Yoonshik-QMI2
Katz, Nadav-QMI31
Kendon, Viv-QMI16, QMI29, QMI3, QMI7,
QWA2
Khoury, Antonio Zelaquett-QMI10, QMI11,
QMI21, QMI22, QMI6
Kielpinski, David-QTuD4
Killoran, Nathan-QTuG6
Kim, Hyochul-QMD3
Kleckner, Dustin-QME2, QTuD3
Klimov, Andrei B-QTuH2
Kobayashi, Takayoshi-QMI30
Kolchin, Pavel—PDPB2
Kolobov, Mikhail I-QWD5
Krauter, Hanna-QMH1
Krishnamurthy, Pradeep Kumar-QMI36
Kurizki, Gershon-QTuC1
Kwiat, Paul G-QWC5, QWD6

L

Laghaout, A.-QTuH5
Lam, Ping Koy-QTuG1
Laurat, Julien-QTuE6
Lavery, Martin Philip John-QTuE3
Leach, Jonathan-QTuE2, PDPA1
Lee, Keun-QMI26
Lee, Sang Min-QMI2
Lett, Paul—PDPA2
Leuchs, Gerd-QMF2, QTuH2
Liapis, Andreas C-QMB2

Lo, Hsin-Pin-QMI30
Locatelli, Massimiliano-QMG2
Love, Gordon D-QTuE3
Lovett, Neil-QMI16
Lugiato, Luigi A-QTuF2
Lukin, Misha-QMB1
Lukishova, Svetlana G-QMB2
Lukishova, Svetlana G.-QWD3
Luo, Chih-Wei-QMI30
Lupo, Cosmo-QWC6
Lvovsky, Alexander-QTuH4
Lynn, Theresa-QMI25
López, Carlos E.-QMI37
Löffler, Wolfgang-QMD2
Lütkenhaus, Norbert-QMF3, QTuG6,
QWC4

M

Ma, Xiongfeng-QMF3
Malik, Mehul-QTuE4
Mani, Ashish-QMI28
Marino, Alberto—PDPA2
Marquardt, Christoph-QTuH2
Martinelli, Marcelo-QTuH3
Megidish, Eli-QTuB2, QWD1
Meyer Petersen, Jonas-QMH1
Miatto, Filippo-QTuF6
Milburn, Gerard James-QTuD2, QTuG7
Milman, Perola-QMI22
Minaeva, Olga V-QMI1
Minar, Jiri-QTuA2
Monken, Carlos-QTuF1
Morizur, Jean-François-QTuF5
Munro, William J-QMI3, QTuC2
Murugkar, Sangeeta—PDPA1
Muschik, Christine-QMH1
Mücke, Martin-QWB2

N

Naboichek, Steven-QMI26
Naseri, Mosayeb-QMI42
Nemoto, Kae-QTuC2
Neuzner, Andreas-QWB2

Nikolopoulos, Georgios M-QMI20
Nishizawa, Norihiko-QMI13
Nomoto, Sean-QMI18
Nor-Meyl, Malena-QMI6
Norton, Benjamin-QTuD4
Novensterl, Matthew-QMI18
Nussenzveig, Paulo-QTuH3
Nölleke, Christian-QTuG3, QWB2

O

O'Brien, Jeremy-QMD1
O'Sullivan, Malcolm-QTuE4
Oblak, Daniel-QTuG2
Oemrawsingh, Sumant-QMD3
Okamoto, Ryo-QMI13
Okano, Masayuki-QMI13
Oulton, Rupert F. — PDPB2
Oxman, Luis-QMI21

P

Pachón, Leonardo A.-QMI24
Padgett, Miles-QTuE2, QTuE3, QTuF6, PDPA1
Park, Hee Su-QMI2
Pascazio, Saverio-QWC3
Patera, Giuseppe-QWD5
Peeters, Wouter-QME4
Peng, Xiang-QMI19
Pepper, Brian-QME2, QTuD3
Pereira, Marcelo V-QTuF1
Petrasianas, Matt-QTuD4
Petruccione, Francesco-QMH2
Piani, Marco-QWC4
Pinel, Olivier-QTuH1
Pisenti, Neal-QMI25
Pitkanen, David-QMF3, QWC4
Polycarpou, Constantina-QMG2
Polzik, Eugene-QMH1

Q

Qi, Bing-QMI5

R

Raimond, Jean-Michel-QWC3
Ralph, Timothy C.-QMF4
Rangarajan, Radhika-QWC5
Rehacek, Jaroslav-QTuC3
Reiserer, Andreas-QTuG3, QWB2
Rempe, Gerhard-QTuG3, QWB2
Ricken, Raimund-QTuG2
Rispe, Arnaud-QTuG5
Ritter, Stephan-QTuG3, QWB2
Roa, Luis-QMI27, QMI35
Roberston, David J-QTuE3
Roeck, Nadia-QME1
Romero, Mary J-QTuE2, QTuF6
Romero-Isart, Oriol-QME3
Roy Bardhan, Bhaskar-QWD2
Russell, Philip-QMD2

S

Saglamyurek, Erhan-QTuG2, QTuG5
Samuel, Llea N-QMI38
Sanchez-Soto, Luis L-QTuH2
Sanders, Barry C-QTuB1
Sangouard, Nicolas-QTuA2
Sayrin, C.-QWC3
Schaake, Jason-QWD4
Scharrer, Michael-QMD2
Schleich, Wolfgang-QMC1
Schubert, William-QMI18
Scully, Marlan-QMA1
Sergienko, Alexander V.-QMI1, QTuF4
Shacham, Tomer-QTuB2, QWD1
Shin, Heedeuk-QTuE5
Shwa, David-QMI31
Silberhorn, Christine-QWC2, QWC6
Simon, Christoph-QTuA2, QTuD3, QTuG5
Simon, David S-QMI1, QTuF4
Sinayskiy, Ilya-QMH2
Sinclair, Neil-QTuG2, QTuG5
Slater, Joshua A-QTuG2
Slodicka, Lukas-QME1
Soderholm, Jonas-QTuH2

Sohler, Wolfgang-QTuG2
Sonin, Petro-QME2
Soto, Diego-QMI17
Souza, Carlos Eduardo R-QMI11
Sparkes, Ben-QTuG1
Specht, Holger-QTuG3, QWB2
Stace, Thomas M-QTuC4
Stephens, Ashely M-QTuC2
Streed, Erik-QTuD4
Subashchandran, Shanthi-QMI13

T

Takeuchi, Shigeki-QMI13
Tamma, Vincenzo-QMI8
Tanaka, Akira-QMI13
Thomas, Neuhaus-QMI23
Thon, Susanna-QMD3
Tipsmark, A.-QTuH5
Tittel, Wolfgang-QTuG2, QTuG5
Treppe, Nicolas-QTuF5, QTuH1

U

Uphoff, Manuel-QTuG3, QWB2

V

van Exter, Martin-QMD3, QME4
van Loock, Peter-QMF3
van Nieuwenburg, Evert-QMD3
Villar, Alessandro-QTuH3
Vogl, Ulrich—PDPA2

W

Wang, Cosmos-QMI26
Warburton, Ryan—PDPA1
Wasilewski, Wojciech-QMH1
White, Andrew-QWA1
Wickert, Ricardo M-QMF3
Winkler, Justin-QWD3
Woerdman, Han P-QMD2
Woudenberg, Jasper-QME4
Wu, Shengjun-QMI15
Wölk, Sabine-QMC1

X

Xu, Bingjie-QMI19
Xu, Yuping-QMI33

Y

Yang, Ying-QMI33
Yao, Alison M-QTuF6
Yuasa, Kazuya-QMI4

Z

Zambrini, Roberta-QMI12
Zavatta, Alessandro-QMG2
Zavriyev, Anton-QMI26
Zeilinger, Anton-QWC1
Zerom, Petros-QTuF3
Zhang, Xiang—PDPB2
Zhou, Zhifan—PDPA2
Zhu, Shiqun-QMI33
Zielnicki, Kevin-QWC5
Zueco, David-QMI24

Measuring correlated photon pairs with an EMCCD camera

J. Leach¹, S. Murugkar¹, M. Edgar³, M. J. Padgett³, R. Warburton⁴, P. Srivastava⁵,
R. W. Boyd^{1,2}

¹ Department of Physics, University of Ottawa, Ottawa, Canada

² Institute of Optics, University of Rochester, Rochester, USA

³ Department of Physics and Astronomy, SUPA, University of Glasgow, Glasgow, UK

⁴ Department of Physics, SUPA, Heriot Watt, Glasgow, UK

⁵ 47 Wycliffe St., Ottawa, Canada

Abstract: The multiple pixels and high quantum efficiency of EMCCD cameras make them an attractive technology for quantum optics. We use such a camera to measure correlations present in the two-photon field generated by parametric down-conversion.

© 2011 Optical Society of America

OCIS codes: 270.0270 Quantum optics

Quantum entanglement, one of the defining features of quantum mechanics, is the process where the outcome of measurements on spatially distant particles cannot be separated. It is the basis of many quantum information protocols including quantum key distribution (QKD). Continuous variable QKD, where the spatial degree of freedom of light is used to carry multiple bits of information, promises to increase the data rate and security over conventional QKD. This is provided that it is possible to simultaneously and efficiently detect the multiple states of light that carry the information [1].

The multiple pixels and high quantum efficiency of EMCCD (electron multiplying CCD) cameras make them an attractive technology for observing continuous variable entanglement. Efforts to move towards multi-bit or full-field quantum measurements on single photons using ICCD (intensified CCD) cameras [2, 3], and EMCCD cameras [4] in addition to using a conventional CCD in the high gain parametric downconversion regime [5]. To date, whilst many of these papers observe correlated effects arising from the quantum nature of the light field, the detection of dark counts, clock induced charges and multiple photon-pair events limit the ability to demonstrate the entanglement present in the light field.

In this work, we use an EMCCD camera (Andor iXon 897) to measure the correlations present in the two-photon field generated by parametric down-conversion. For realistic experimental conditions, the signal and idler modes with transverse wavevectors \mathbf{k}_s^\perp and \mathbf{k}_i^\perp , the amplitude of the entangled two-photon state can be written as,

$$\Psi(\mathbf{k}_s^\perp, \mathbf{k}_i^\perp) = \alpha(\mathbf{k}_s^\perp + \mathbf{k}_i^\perp)\phi(\mathbf{k}_s^\perp - \mathbf{k}_i^\perp). \quad (1)$$

Here, $\alpha(\mathbf{k}_s^\perp + \mathbf{k}_i^\perp)$ is the transverse phase matching condition which is a function of the pump beam waist ω_p , and $\phi(\mathbf{k}_s^\perp - \mathbf{k}_i^\perp)$ is the longitudinal phase matching condition which depends on the crystal length L and the wavelength of the pump λ_p . The longitudinal phase matching condition determines the total spread of wavevectors generated by the down-conversion and sets whether or not one is in a colinear or non-colinear regime. The transverse phase matching condition sets the strength of the correlations and the conditional probability of measuring the signal photon in mode \mathbf{k}_s^\perp , given that the idler photon is in mode \mathbf{k}_i^\perp is [4],

$$P(\mathbf{k}_s^\perp | \mathbf{k}_i^\perp) \propto \exp \left[-\frac{\omega_p^2}{2} |\mathbf{k}_s^\perp + \mathbf{k}_i^\perp|^2 \right]. \quad (2)$$

Here, the width of this distribution is set only by the size of the pump beam illuminating the crystal. It is the uncertainty in the transverse momentum of the pump, due to its finite size, that is transferred to the correlation between the signal

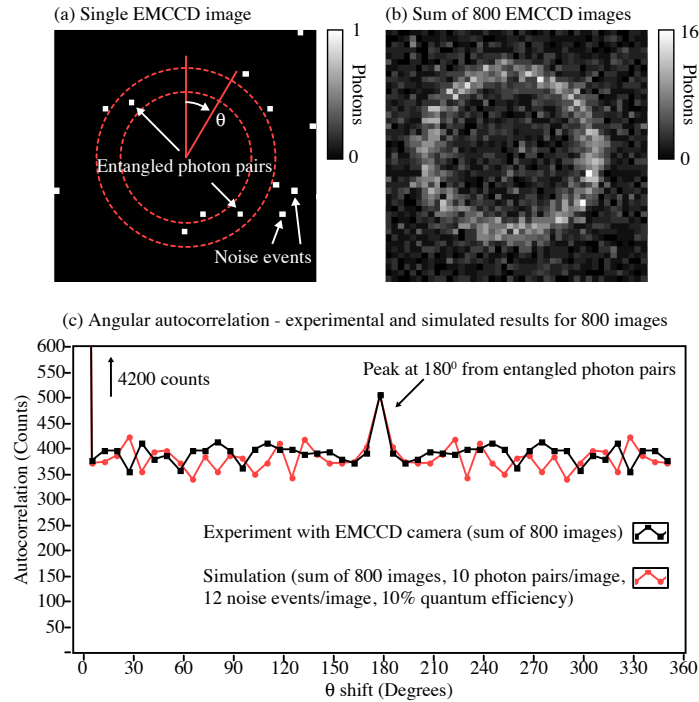

Fig. 1. (a) Sample image from a single exposure of the EMCCD camera. (b) Image of the down-converted ring obtained by summing the photon counts from 800 images individual images. (c) Angular autocorrelation results from the experiment (black squares) and simulation (red circles). The parameters for the simulation were chosen to obtain a result that closely fits the experimental results. This corresponded to a quantum efficiency of the entire optical system of $\approx 10\%$.

and idler photons. It is these transverse momentum correlations that are present in the light field that we measure with the EMCCD camera.

The experimental system, uses a mode-locked (100MHz) $\lambda_p=355\text{nm}$ pump source, which is focussed into a 3mm long BBO crystal, cut for degenerate type-1, non-collinear down-conversion. The beam waist of the pump at the crystal is approximately $\omega_p=1\text{mm}$ and the signal and idler down-converted beams are set to have a small angular separation of a few degrees. The small angular separation means that although we are in a non-collinear regime, both signal and idler pass through the same imaging optics before they are incident on the EMCCD camera. The optics imaged the down-converted ring occupied to a small region on the camera (a radius of approximately 15 pixels) whilst maintaining the imaging criteria of imaging the far-field of the crystal. Neutral density filters of strength $\text{ND}=4$ were placed in the path of the pump source to attenuate the photon pair production rate such that the camera recorded only a few events per frame. The camera was used in photon-counting mode so that conversion from counts to photons was performed in software.

It is important to note that whilst it is possible to observe the down-converted ring with the camera in almost any imaging plane, it is only in the far-field and the image-plane of the crystal that signal and idler modes will exhibit strong intensity correlations. In all planes other than these, the signal and idler fields remain correlated although one has to measure the amplitudes of the fields to measure this effect [6]. In this experiment we measure only in the far-field of the crystal where the signal and idler modes are anti correlated in their transverse momenta therefore great care was taken to ensure that the camera measured precisely in this plane. This is not a concern when there is independent control of the signal and idler modes as in the standard case where optical fibers on translation stages are used to measure the correlations.

The EMCCD camera was used to collect 800 images. Each single image was a sparse array where the counts represent events arising from either entangled photon pairs, unentangled photon events or clock induced charges in the readout of the camera. The down-converted ring cannot be identified in the single images, see Fig. 1(a) for an example, whereas in the sum of the images the ring can be seen, Fig. 1(b). By looking at the integrated angular autocorrelation of many individual images from the camera, we detect a peak in the correlation at θ shift = 180° , see Fig. 1(c). The

PDPA1.pdf

origins of this peak are the correlated photon pairs present in the down-converted field. In addition to the experimental data (black squares in Fig. 1(c)), we present modeled data (red circles Fig. 1(c)) where we control parameters such as the number of photon pairs per image, the number of unwanted noise events from either clock induced charges (CICs) or from unwanted photons getting to the camera and the overall quantum efficiency. A detailed comparison between the modeled and experimental results provides an insight into the capabilities of EMCCD cameras for detecting single photons. For example, good fits of the modeled data to the experimental data occur for quantum efficiencies of the entire optical system of order 10%.

Taking quantum mechanics as the underlying principle behind the correlations, the correlations certainly arise from the production of entangled photons. In our case however, in addition to not measuring correlations in the near-field, due to the high background level, the strength of the correlations is far from any limit one requires to prove the photon pairs are entangled. Clearly, fewer noise events per image, fewer photon pairs and a higher overall quantum efficiency will move the experimental results closer to this limit. Whilst the current camera technologies may not be able to prove entanglement, they are certainly sensitive enough to observe effects that arise from quantum processes. Characterising the current state of the art single photon cameras is an important step in understanding the role of such detectors in other areas of imaging and quantum information science. Ultimately, multi-pixel detectors of this nature are necessary for full-field demonstrations of the Einstein-Podolsky-Rosen paradox [7] and for high data rate multi-bit quantum key distribution.

References

1. L. Zhang, C. Silberhorn, I. A. Walsmley, Phys. Rev. Lett **100**, 110504 (2008)
2. B. Jost *et al.*, Optics Express, **3** 81 (1998)
3. M. Hamar *et al.*, Phys. Rev. A **81**, 043827 (2010)
4. L. Zhang, L. Neves, J Lundeen, I. A. Walsmley, Journal of Physics B **42**, 114011 (2009)
5. O. Jedrkiewicz *et al.*, Phys. Rev. Lett **93**, 243601 (2004)
6. K. W. Chan, J. P. Torres, J. H. Eberly, Phys. Rev. A **75**, 050101 (R) (2007)
7. A. Einstein, B. Podolsky, N. Rosen, Physical Review **47** 777-780, (1935)

Four-wave-mixing in hot atomic vapor for spatially multimode squeezed light generation

Q. Glorieux, J. Clark, N. Corzo-Trejo, Z. Zhou, R. Glasser, A. Marino, U. Vogl, P.D. Lett

Joint Quantum Institute, National Institute of Standards and Technology, and University of Maryland, Gaithersburg, Maryland 20899, USA

quentin.glorieux@nist.gov

Abstract: Four-wave-mixing in hot atomic vapor is a versatile tool for spatially multimode squeezed light generation. We demonstrate multimode behavior for different pump-probe configurations producing either single beam squeezing or twin beams. To illustrate the usefulness of such fields, we perform an imaging experiment with two quantum correlated vacuum (squeezed) beams, where the spatially multimode character of squeezing is used to reconstruct an arbitrarily chosen pattern.

© 2011 Optical Society of America

1. Introduction

Four-wave-mixing (4WM) is a well known non-linear $\chi^{(3)}$ effect used to generate non-classical light. One of the first demonstrations of squeezed light was based on this effect [1]. Nevertheless, over the last 20 years, attention has been mainly focused on $\chi^{(2)}$ because of the availability of high quality optical crystals. Recently, there is a regain of interest for the 4WM, both experimentally [2–7] and theoretically [8]. Up to -9.2 dB below the standard quantum limit has been demonstrated [6]. One of the major advantage of 4WM experiments is the absence of cavity to enhance the non-linear effect, which allows the generation of spatially multimode squeezed beams [2–4]. In this paper we demonstrate this multimode behavior for several pump-probe configurations producing either single beam squeezing or twin beams and we investigate the enhancement of sensitivity for a shape recognition experiment using multi-spatial-mode squeezing beams.

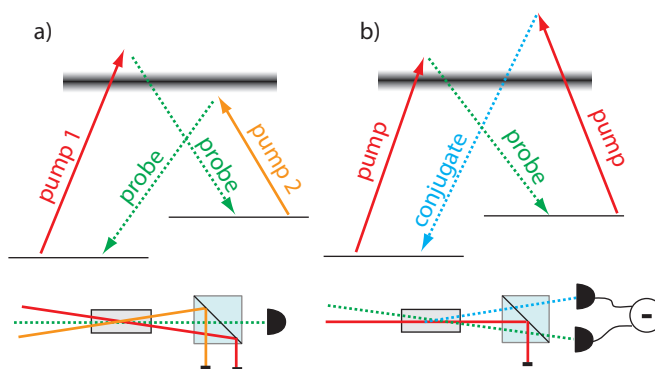

Fig. 1. Four-wave-mixing in hot atomic vapor. Level schemes and schematic of the experimental setup for a) Phase-sensitive amplifier b) Phase-insensitive amplifier.

2. Phase sensitive amplifier

A phase-sensitive amplifier (PSA) is based on a parametric process that can amplify or deamplify a signal depending on the phase of the input. Using four-wave-mixing in hot atomic vapor in the PSA configuration (see figure 1a), we generate bright quadrature squeezed states of light and, when working unseeded, vacuum squeezed light. The

squeezing is observed for a wide range of pump powers and probe detunings on the D1 line of ^{85}Rb . The maximum squeezing measured (-3 ± 0.2 dB) is to our knowledge the best results reported in an atomic medium (figure 2a).

Moreover, the squeezing is present in different transverse spatial modes of the single output beam, making our system one of the first sources of multi-spatial-mode quadrature squeezed light. To demonstrate the presence of several spatial modes, we compare the effects of losses on the squeezing measurement by several methods : a global attenuation with neutral density filters and a by cutting the beam and selecting smaller spatial modes with an iris or a blade from the side or from top (see figure 2b). As the global attenuation shows a well known linear behavior, we can see on figure 2c that the different cutting methods are far away from the linear attenuation, demonstrating the existence of smaller coherence areas and the multimode behavior of the squeezing.

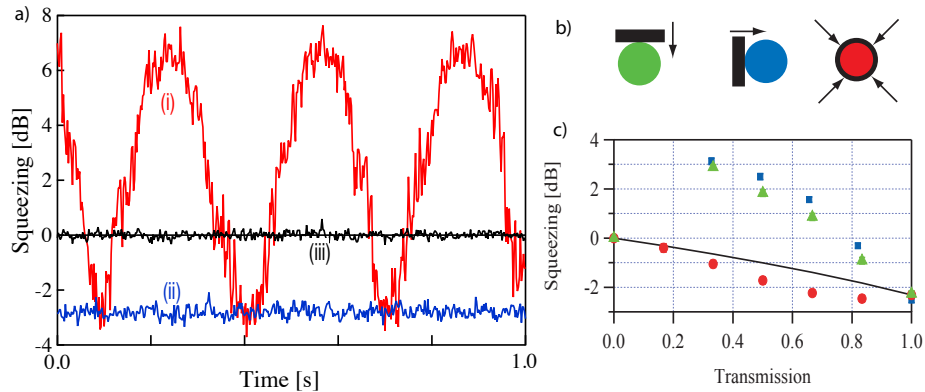

Fig. 2. a) Noise normalized to standard quantum limit (SQL) as a function of time for an unseeded process (squeezed vacuum). The shot noise is given by the black trace (iii), and the quadrature noise measurement is given by the red trace (i). By using a locking system described in [9], we can lock to the minimal noise measurement (ii). b) Schematics of the different ways for beam clipping. c) Noise normalized to SQL as function of the transmission for global attenuation (plain black) or for different methods of clipping : green triangles for a blade from the top, blue squares for a blade from the side, red dots for an iris.

3. Quantum mask game

In a different configuration for probe and pump beams, the so-called phase insensitive amplifier (PIA) (see figure 1b), we use the multi-spatial-mode property of the generated beams to propose a simple *quantum game* as a proof of principle. Twin beams of squeezed vacuum are generated by Alice using four-wave mixing on the D1 line of ^{85}Rb . Bob selects an arbitrarily shaped mask (e.g. the letter "K" in the alphabet) and places it in the path of one of the quantum correlated squeezed vacuum fields. Then, Alice dynamically shapes two local oscillators using a spatial light modulator, in order to perform balanced homodyne detection simultaneously on both the obstructed beam as well as its unobstructed twin. The object of the game for Alice is to find the transverse profile of the mask chosen by Bob by programming the spatial light modulator to search for the local oscillator shape that matches that of the squeezed vacuum leaking through the mask (figure 3a-b).

We demonstrate experimentally the feasibility of this *quantum mask game* (figure 3c), and we show that, by using information obtained by the detection of both beams, we can resolve the shape of the partially obstructed mask with an enhanced sensitivity over that which can be obtained using classical states of light .

4. Conclusion

In this paper we have demonstrated the usefulness of 4WM for multi-spatial-mode squeezed light generation. We have shown up to -3 dB of noise reduction below the SQL in the case of PSA and we have demonstrated the role of multi-spatial-mode squeezing to enhance the sensitivity in a quantum imaging experiment [10, 11]. Let us stress that this source is also intrinsically matched to an atomic transition and therefore this opens the way to the storage of quantum images in an atomic based quantum memory.

PDPA2.pdf

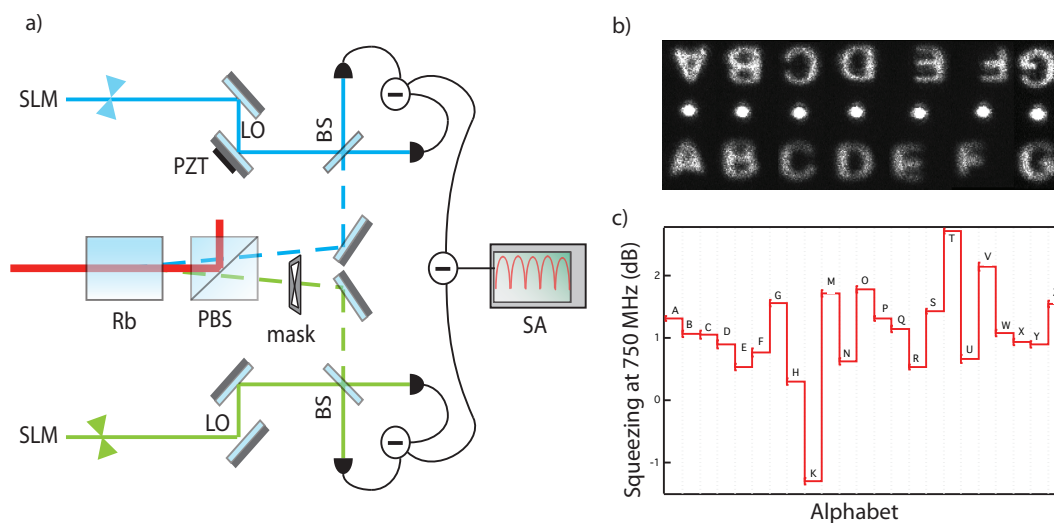

Fig. 3. a) Experimental setup for the *quantum mask game*. Two quantum correlated vacuum beams (green and blue dashed) are generated by Alice. Bob inserts an arbitrary mask in the path of one the vacuum beam. Alice shapes the local oscillator beams (LO) with a spatial light modulator (SLM) to maximize the measured squeezing using two homodyne detections and a spectrum analyzer (SA). b) Example of an alphabet of shapes which can be used for this experiment. From the top : probe beam, non-filtered pump, conjugate beam. c) Experimental demonstration of pattern recognition with quantum correlations. Letters are shaped with the SLM to recognize the mask pattern. K is a clear answer to the pattern recognition.

References

1. R E Slusher, L Hollberg, B Yurke, and J Mertz. Observation of squeezed states generated by four-wave mixing in an optical cavity. *Phys Rev L* **55**, 222409 (1985)
2. R.C. Pooser, A. Marino, V. Boyer, K. Jones, P.D. Lett. Low-Noise Amplification of a Continuous-Variable Quantum State. *Phys Rev L* **103**, 010501 (2009)
3. V. Boyer, A. Marino, R.C. Pooser, P.D. Lett. Entangled Images from Four-Wave Mixing. *Science* **321**, 544 (2008)
4. V. Boyer, A. Marino, P.D. Lett. Generation of spatially broadband twin beams for quantum imaging. *Phys Rev L* **100**, 143601 (2008)
5. Q Glorieux, S Guibal, L Guidoni, J P Likforman, T Coudreau, and E Arimondo. Strong quantum correlations in four wave mixing in ^{85}Rb vapor. *Proceedings of SPIE Quantum Optics* edited by V. Zadkov, **7727**, (2010)
6. Q Glorieux, L Guidoni, S Guibal, J P Likforman, T Coudreau. Quantum correlations by four-wave-mixing in an hot atomic vapor in non-amplifying regime : a quantum beam splitter for photons. Available on arxiv.org quant-ph (2011).
7. I H Agha, C Giarmatzi, Q Glorieux, T Coudreau, P Grangier, and G Messin. Time-resolved detection of relative-intensity squeezed nanosecond pulses in an ^{87}Rb vapor. *New Journal of Physics* **13**, 043030 (2011)
8. Q Glorieux, R Dubessy, S Guibal, L Guidoni, J P Likforman, T Coudreau, and E Arimondo. Double-lambda microscopic model for entangled light generation by four-wave-mixing. *Phys Rev A* **82**, 033819 (2010)
9. K McKenzie, E E Mikhailov, K Goda, P K Lam, N Grosse, M B Gray, N Mavalvala, and D E McClelland. Quantum noise locking. *J. Opt. B*, **7**, 421 (2005)
10. L Lopez, N Treps, B Chalopin, and C Fabre. Quantum processing of images by continuous wave optical parametric amplification. *Phys Rev L* **100**, 013604 (2008)
11. Brida G, Genovese M, Berchera I. R. Experimental realization of sub-shot-noise quantum imaging, *Nature Photonics* **29**, (2010)

Longer Baseline Telescope Arrays Using Quantum Repeaters

Daniel Gottesman¹, Thomas Jennewein², Sarah Croke^{1,*}, Latham Boyle¹

¹*Perimeter Institute for Theoretical Physics, 31 Caroline St N, Waterloo, ON N2L 2Y5, Canada*

²*Institute for Quantum Computing and Department of Physics and Astronomy, University of Waterloo, Waterloo, ON N2L 3G1, Canada*

* *scroke@perimeterinstitute.ca*

Abstract: Interferometry among telescope arrays has become a standard technique in astronomy. We discuss using quantum repeaters to increase the baseline length, and therefore resolving power, of telescope arrays at optical observing frequencies.

© 2011 Optical Society of America

OCIS codes: 270.5585, 350.1260.

1. Introduction

Interferometry among telescope arrays has become a standard technique in astronomy [1], allowing greater resolving power than would be available to any plausibly-sized single telescope. For radio frequencies, interferometry can be performed robustly even between telescopes spread across the planet. Interferometry between telescopes operating at infrared or optical frequencies is also possible, but fewer photons arrive at these high frequencies, making interferometry much more difficult. In today's IR and optical interferometric arrays, photons arriving at different telescopes must be physically brought together for the interference measurement, limiting baselines to a few hundred meters at most because of phase fluctuations and photon loss in the transmission. In telescope design, the arriving light is usually treated classically, but when the number of photons arriving is small, the quantum state of the light may become important. The field of quantum information has extensively studied the task of reliably sending quantum states over imperfect communications channels. The technology of quantum repeaters, currently under development, can, in principle, allow the transmission of quantum states over arbitrarily long distances with minimal error. We discuss how to apply quantum repeaters to the task of optical and infrared interferometry to allow telescope arrays with much longer baselines than existing facilities.

2. Direct detection optical interferometry

We begin by reviewing the standard approach to optical and infrared interferometry, known as “direct detection,” but we will perform the analysis by assuming that only a single photon — rather than a classical wave — is arriving from the source. We consider first an idealized set up with two telescopes and no noise, as pictured in figure 1. Because the source may not be directly overhead, light must travel an additional distance $b \sin \theta$ to reach telescope L than to reach telescope R, where b is the length of the baseline and θ is the angle from vertical of the source. If the light has wavelength λ , the extra distance means that the light arriving at telescope L has a phase shift $\phi = (b \sin \theta)/\lambda$ relative to the light arriving at telescope R. We have a single photon arriving, but it could arrive at either telescope, and since the source is far away, the probability of arriving at each telescope is equal. We thus have the state

$$|0\rangle_L |1\rangle_R + e^{i\phi} |1\rangle_L |0\rangle_R. \quad (1)$$

If we can measure ϕ with very high precision, that tells us the location of a point source very precisely. More generally, we are interested in sources that have some structure on the scale we can resolve with the interferometer, in which case the state reaching the telescopes is a mixture of photons coming from different locations on the source. If we now consider interference between the light arriving at telescope L and that arriving at telescope R, we measure not just a phase ϕ , but a visibility function \mathcal{V} with both an amplitude and a phase. $\mathcal{V}(\vec{b})$ is a function of not just the size but also the orientation of the baseline between the telescopes. The van Cittert-Zernike theorem (see [1]) states that the visibility (as a function of the baseline) is the Fourier transform of the source distribution. With just a single pair of telescopes

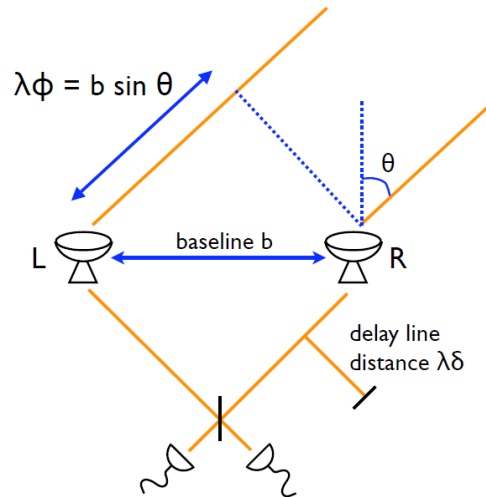

Fig. 1. Basic set-up of a direct detection interferometer

with a fixed baseline, we don't have enough information to reconstruct the original source brightness distribution, but when we have an array of telescopes with a variety of different baselines, we get much more information. If we could measure the visibility for all baselines, we could completely image the source. With only a limited number of baselines, the discrete Fourier transform may nonetheless give a good approximation of the source brightness distribution.

In the standard set-up, shown in figure 1, photons are physically brought back together (with a variable phase δ applied in the light from telescope R) and recombined in a Michelson interferometer. One of the difficulties involved in implementing this set-up is that it is difficult to transport single photons over long distances without incurring some additional uncontrolled phase shifts, producing reduced interference fringes. The signal we wish to measure is the amount of interference — for instance, a point source should have complete constructive and destructive interference, while a uniformly bright field of view should have no interference at all. Since many different error mechanisms also cause a reduction in the interference visibility, this is a serious problem. Loss of photons in transmission can also be an issue. In practice, these problems limit the baseline size of interferometers using direct detection. Today's best optical and infrared interferometers use baselines of only a few hundred meters at most.

3. Using Quantum Repeaters to Improve Interferometry in Astronomy

The task of transporting quantum states and correcting errors on quantum states has been intensively studied in the field of quantum information. For the specific task of interferometry, the most relevant strategy seems to be to use a quantum repeater [2–4]. Instead of sending the valuable source photons directly over a noisy quantum communications channel, one should instead produce a maximally entangled state such as $|01\rangle + |10\rangle$, and distribute that over the channel. The entangled state is known and replaceable, so we can check to see that it has arrived correctly. If it has, then we can transmit the state of the source photon using teleportation.

In the particular case of an interferometric telescope, it is not necessary to perform the teleportation explicitly, as we can use the entangled pair directly to measure the visibility. Consider the setup of figure 2. We now have two separate interference measurements, one at telescope L and one at telescope R. In the simplest version, we post-select on the measurement results, considering only the case where we see one photon at telescope L and one photon at telescope R. One of these photons has come from the astronomical source, and one has come from the entangled pair, but we have no way of knowing which is which. On each side, there are two detectors, and the probability of seeing a photon at the two detectors is equal. The signal we wish to measure is contained not in the number of photons seen at any given detector, but in the correlation between which L detector clicks and which R detector clicks.

Half the time, both photons will arrive on the same side. We discard those cases, and focus just on the instances where we have one photon on each side. We lump together pairs of outcomes. The total probability of seeing a correlation, conditioned on having one click at each telescope, may be shown to be $[1 + \text{Re}(\mathcal{V}e^{-i\delta})]/2$, while the total

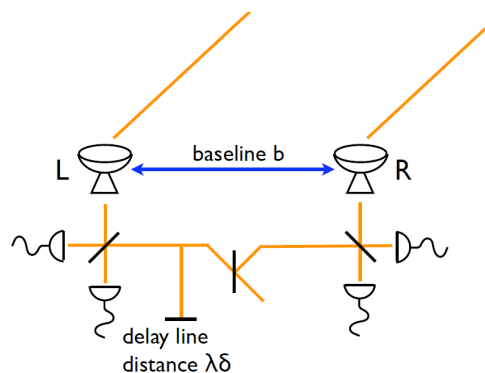

Fig. 2. Performing an interference measurement between two telescopes using an entangled state.

probability of seeing an anticorrelation is $[1 - \text{Re}(\gamma e^{-i\delta})]/2$. The measurement of correlation vs. anticorrelation thus tells us the same information as the two outputs of a Michelson interferometer in a direct detection experiment.

4. Discussion

It is instructive to compare our quantum repeater-based interferometer with heterodyne interferometry. In heterodyne interferometry, light coming in to each telescope in the array is mixed via beam splitter with a laser, and photodetectors measure the relative phase between the photon from the source and the laser. In order to make full use of this information, the lasers at different locations should be phase-locked. The usual way to assure this is to start with just one laser and split it up, sending the beam to different locations. The resulting set up looks very much like our quantum repeater set up. The only difference is that in heterodyne interferometry, the laser connecting different telescopes is strong, whereas our entangled state is very weak (single photon or equivalently our set-up can use a weak coherent state with post-selection). The big difference is that using a weak state and post-selecting on single-photon measurements means that there is entanglement between the two sides. Heterodyne interferometry is ultimately limited by quantum noise in the laser, which can swamp the signal we are trying to see when the source is very faint. That problem does not afflict our quantum repeater protocol, since the entanglement between the telescopes lets us compare correlations in the measurement outcomes. The quantum noise is not gone — it appears in the fact that the measurement on each side (L or R) is, by itself, completely random. The use of an entangled state means that the noise on the L and R sides is correlated, so it cancels out when look at the correlation/anti-correlation between the measurements.

The quantum repeater approach presents some challenges - we need a high rate single photon source, so that there is always an entangled photon in the interferometer when a source photon arrives. The entangled photon also needs to be well-matched in spatial and frequency modes to the source photon, in order to see interference. Frequency matching can be achieved by filtering, but reducing the detection bandwidth means reducing the number of photons received, which is clearly undesirable when observing a weak source. Spatial matching can be achieved by e.g coupling into fibres, but this also results in losses. Finally, we would like the repeater technology to work over a range of wavelengths to enable observations over this range. Nevertheless, quantum repeaters offer the prospect of dramatically increasing the baselines of interferometric telescope arrays operating in the optical and infrared, allowing astronomers to probe the structure of sources on scales not accessible with current techniques.

References

1. J. D. Monnier, "Optical interferometry in astronomy," *Rep. Prog. Phys.* **66**, 789–857 (2003).
2. Nicolas Sangouard, Christoph Simon, Thomas Coudreau, and Nicolas Gisin, "Purification of single-photon entanglement with linear optics," *Phys. Rev. A* **78**, 050301 (2008).
3. D. Salart, O. Landry, N. Sangouard, N. Gisin, H. Herrmann, B. Sanguinetti, C. Simon, W. Sohler, R. T. Thew, A. Thomas, and H. Zbinden, "Purification of Single-Photon Entanglement," *Phys. Rev. Lett.* **104**, 180504 (2010).
4. L.-M. Duan, M. Lukin, J. I. Cirac, and P. Zoller, "Long-distance quantum communication with atomic ensembles and linear optics," *Nature* **414**, 413–418 (2001).

Strong interaction of distinct single photons via a single atom in a waveguide

Pavel Kolchin*¹, Rupert F. Oulton¹ and Xiang Zhang^{1,2}

¹Nanoscale Science and Engineering Center, 3112 Etcheverry Hall, University of California, Berkeley, CA 94720, USA.

²Materials Sciences Division, Lawrence Berkeley National Laboratory, 1 Cyclotron Road, Berkeley, CA 94720, USA.

*Author email address: pdkolchin@gmail.com

Abstract: We propose a waveguide QED scheme where distinct single photons interact strongly at a ladder or V-type atom. When both atomic transitions are strongly coupled to the waveguide, photon tunneling and a π phase shift is induced by another distinct photon.

© 2011 Optical Society of America

OCIS codes: 270.5580, 270.5585, 020.5580, 190.4380

Strong nonlinear interactions between two distinct optical signals at the few photon level are critical for quantum logic devices [1]. While resonant interactions in dense atomic ensembles exhibit nonlinearities considerably larger than those of conventional materials, they require a large number of atoms with dark states at cold temperatures to control single photons. Meanwhile, cavity-enhanced QED systems can enable nonlinear interactions at the single atom level. Recently, it was identified that a single two-level atom coupled to a waveguide mode can induce strong interactions between degenerate photons [2, 3]. Unlike cavity-based enhancements, which control photon interactions at discrete modes, waveguide-based enhancements access a one dimensional continuum of reflection and transmission modes, making them ideal for nonlinear frequency mixing of single photons.

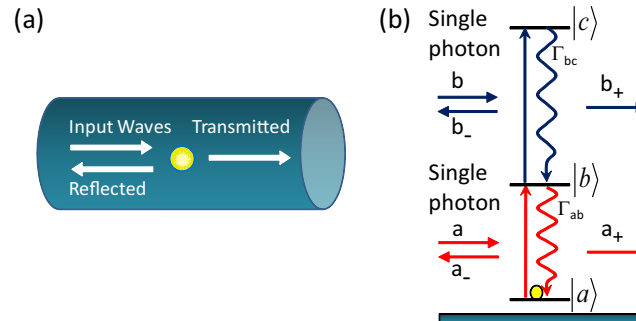

Fig. 1. Two-photon scattering on a ladder-type atom coupled to waveguide. (a) Schematic of the system. (b) Energy level diagram.

In this paper we propose a waveguide-QED scheme to achieve a nonlinear interaction of two frequency or polarization distinct single photons at the ultimate limit [4]. The interaction can occur at a single ladder or V-type three level atom, where here, we consider the ladder configuration. Λ -type atoms are not suitable because the shared upper state inhibits simultaneous strong coupling of both optical transitions to the waveguide. Figure 1 shows a schematic of the photon scattering processes and the atom's energy level diagram. A stream of waveguide photons with two different frequencies (polarizations) are applied in resonance with the atomic transitions. The lower atomic transition $|a\rangle \rightarrow |b\rangle$ is used as the quantum probe channel, whereas the upper transition $|b\rangle \rightarrow |c\rangle$ is used as the quantum control channel. We show that the nonlinear interaction can be tremendously enhanced by the strong coupling if the cascade atomic transitions to the waveguide mode simultaneously. As a result, a control photon tuned to the upper transition induces a phase shift and tunneling of a probe photon tuned to the otherwise reflective lower transition.

In order to understand the physics of the two-photon scattering process, we analyze the second order intensity correlations for transmitted and reflected photons shown in Fig. 2. These correlations are a result of Fano-type interference

between photon pairs interacting with the atom via three possible pathways as shown in Fig. 2(a). In the first pathway the atom remains unperturbed and both incident photons are transmitted. In the second pathway the atom undergoes excitation of its lower transition with incident photon a scattered and photon b transmitted without change. In the third pathway, both incident photons excite the atomic cascade $|a\rangle \rightarrow |b\rangle \rightarrow |c\rangle$ followed by correlated photon pair emission. When both atomic transitions are strongly coupled to waveguide modes, photon a 's has low probability to be reflected and high probability to be transmitted during the spontaneous decay time ($1/\Gamma_{ab}$) after the detection of transmitted photon b . This manifests conditional photon tunneling. Moreover, we show that reflected photon a acquires an extra π phase shift if photon b is also reflected.

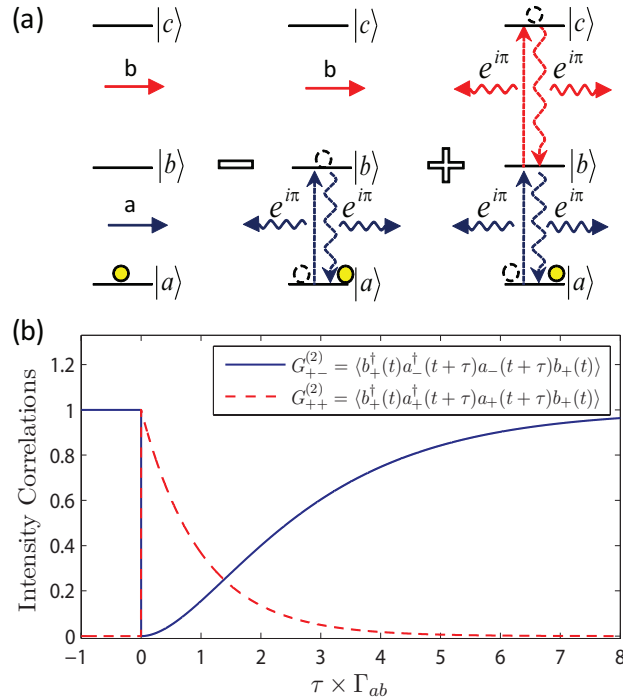

Fig. 2. (a) The interference of two-photon scattering processes for an atom in waveguide. The vertical arrows denote the atomic excitation and emission processes. The horizontal straight and wavy arrows denote input and scattered photons respectively. The large '+' and '-' signs indicate constructive and destructive interference. (b) Two-photon intensity correlations $G^{(2)}(\tau)$ between transmitted control photon $b_+(t)$ and transmitted ('+') or reflected ('-') probe photon $a_{\pm}(t+\tau)$. If both atomic transitions are strongly coupled to the waveguide mode, a strong photon-photon interaction results in the forward scattering of photon a immediately after a transmitted photon b_+ is detected.

References

1. D. Bouwmeester, A. Ekert, A. Zeilinger, *The Physics of Quantum Information* (Springer, Berlin, 2000).
2. K. Kojima, H.F. Hofmann, S. Takeuchi, and K. Sasaki, "Nonlinear interaction of two photons with a one-dimensional atom: Spatiotemporal quantum coherence in the emitted field," *Phys. Rev. A* **68**, 013803 (2003).
3. J. T. Shen and S. Fan, "Strongly Correlated Two-Photon Transport in a One-Dimensional Waveguide Coupled to a Two-Level System," *Phys. Rev. Lett.* **98**, 153003 (2007).
4. P. Kolchin, R. F. Oulton, and X. Zhang, "Nonlinear Quantum Optics in a Waveguide: Distinct Single Photons Strongly Interacting at the Single Atom Level," *Phys. Rev. Lett.* **106**, 113601 (2011).

Quantum Discord and Quantum Entanglement's Attempts to Capture Quantum Correlations

Asma Al-Qasimi* and Daniel F. V. James[†]

Department of Physics, University of Toronto, Toronto, Ontario, M5S 1A7, Canada

*alqasimi@physics.utoronto.ca, [†]dfvj@physics.utoronto.ca

Abstract: We study the newly discovered quantum correlation known as quantum discord numerically and compare it to the traditional entanglement. We also look at its relation with entropy to draw conclusions about its susceptibility to decoherence.

OCIS codes: 000.6800; 270.5585

The inability to factor a state of a quantum system into a product of states of its subsystems is a criterion that is used to define quantum entanglement. Another approach is to calculate the von Neumann entropy of the reduced density matrix to see how much randomness is introduced into the system by discarding information about one of its constituents. This idea serves as a basis for defining many measures of entanglement and can be extended to the mixed state case such as in the case of concurrence [1], where it is defined for the general two-qubit quantum system to make it a convenient tool to study entanglement and its evolution in various systems.

It is accepted that one of the unintuitive characteristics of measurements in quantum systems is that they disturb them. They do so by projecting the state of the systems into one that does not necessarily resemble the initial state before measurement. Based on this idea, Zurek and Ollivier [2] defined a quantity that describes the quantumness of the system; they named this property Quantum Discord. Given a system C composed of two subsystems A and B, the mutual information function, $I(\rho)$, where ρ is the density matrix describing the whole system, tells how much information one can obtain about system A if the state of system B is known (and vice versa). The correlations between the two subsystem can be classical and/or quantum. However, if the correlations are quantum in nature, then calculating $I(\rho)$ after a measurement is performed on one of the subsystems (say B) will yield a *different* result from the one calculated *before* the measurement is performed. In other words, the mutual information function and the measurement-induced mutual information function do not agree in this case. This disagreement is the basis for the definition of discord. The definition is finalized after optimizing over all possible measurements. Zurek and Ollivier showed that for some states that have zero entanglement, discord can still be nonzero. This shows that discord is less fragile to the effects of decoherence than entanglement is. Therefore, it has gained recent interest in being used as a resource in quantum information [3].

In this work, we look at the relationship between discord and entanglement for two-qubits (See figure(1)) as well as discord and linear entropy to get an insight into their relation and to classify states that are optimal to be used in quantum computing. We perform the study on the most general density matrices with no restrictions. We show that the states that fall on the boundaries of the plot in figure 1, for example, describing these relations fall under the class of the maximally mixed marginals [4], and they are divided

into three groups: Werner states, α -states, and the β -states. These states are given, respectively, in the computational basis as follows:

$$\hat{\rho}_w = \frac{1}{4} \begin{pmatrix} (1-\chi) & 0 & 0 & 0 \\ 0 & (1+\chi) & -2\chi & 0 \\ 0 & -2\chi & (1+\chi) & 0 \\ 0 & 0 & 0 & (1-\chi) \end{pmatrix}, \hat{\rho}_\alpha = \frac{1}{2} \begin{pmatrix} \alpha & 0 & 0 & \alpha \\ 0 & (1-\alpha) & 0 & 0 \\ 0 & 0 & (1-\alpha) & 0 \\ \alpha & 0 & 0 & \alpha \end{pmatrix}, \text{ and}$$

$$\hat{\rho}_\beta = \frac{1}{2} \begin{pmatrix} \beta & 0 & 0 & \beta \\ 0 & (1-\beta) & (1-\beta) & 0 \\ 0 & (1-\beta) & (1-\beta) & 0 \\ \beta & 0 & 0 & \beta \end{pmatrix}.$$

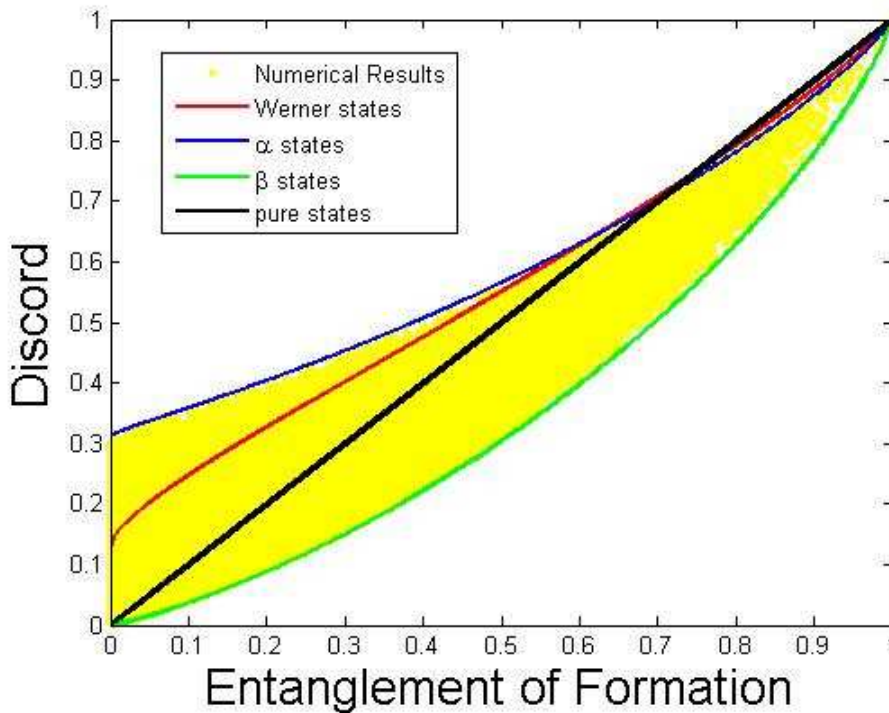

Figure 1: Discord versus Entanglement. Discord (Q) increases as entanglement (E) increases. In fact for the extreme cases of the maximally mixed states and the maximally entangled states, the two correlations take the same values of 0 and 1, respectively. When E is zero, states can be found with $0 \leq Q \leq 1/3$, which are the states found on the Q -axis, and they fall under the two classes of Werner and α -states. From the region where E is 0 till about 0.620, the plot is bound from above by the α -states. From this point up to maximum $E = 0.746$, the bound is given by the Werner states, and then from here up to $E=1$, the pure states bound the relation. From below, the plot is bound by the β -states.

References:

- [1] W. K. Wootters, *Phys. Rev. Lett.* **80**, 2245 (1998).
- [2] Ollivier and W. H. Zurek, *Phys. Rev. Lett.* **88**, 017901 (2001).
- [3] B. P. Lanyon *et al*, *Phys. Rev. Lett.* **101**, 200501 (2008).
- [4] S. Luo, *Phy. Rev. A* **77**, 042303 (2008).