

Seeing Electron in Action

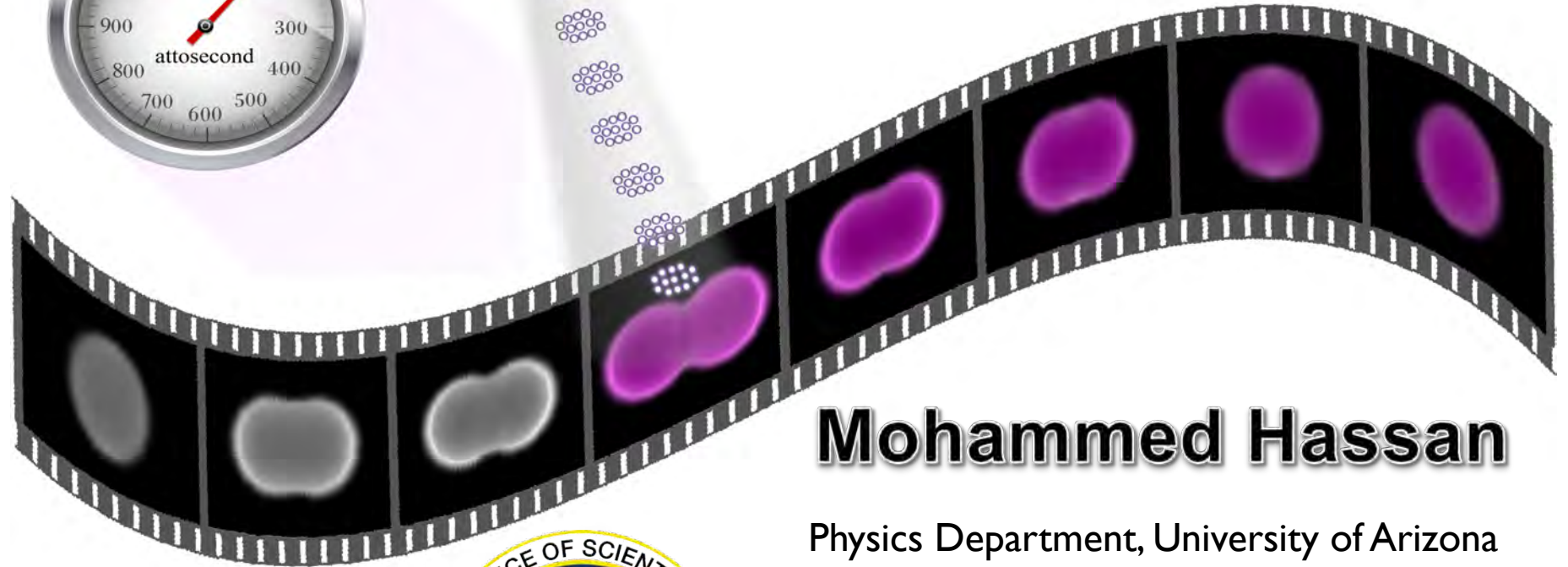

Mohammed Hassan

Physics Department, University of Arizona

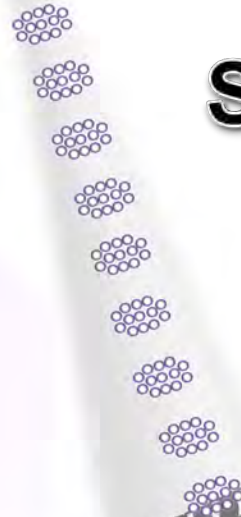

YIP Grant AWARD
NO. FA9550-19-1-0025

GORDON AND BETTY
MOORE
FOUNDATION





<https://cdn.cheapism.com/>

Hassan Ibn al-Haytham

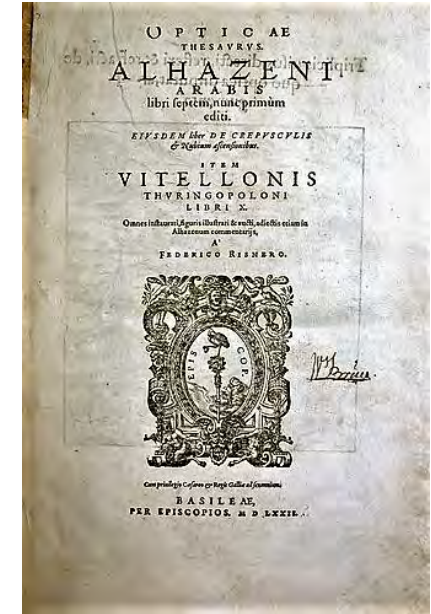
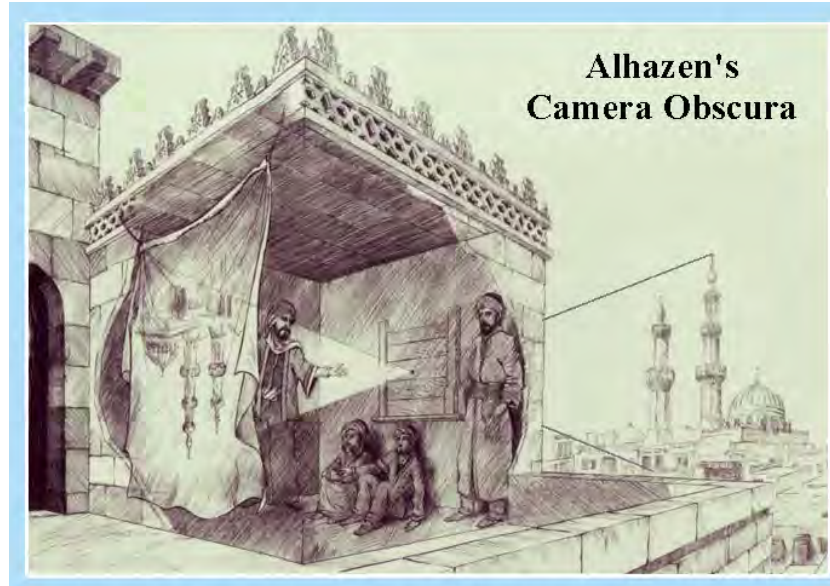

Ibn al-Haytham's seven-volume Book of Optics, published in 1015, greatly influenced the field of optics. However, some aspects of Ibn al-Haytham's work have also been the subject of controversy for historians of science.

Stephen R. Wilk, "Ibn al-Haytham: 1,000 Years after the Kitāb al-Manāẓir," Optics & Photonics News 26(10), 42-48 (2015)

Horse in motion

THE HORSE IN MOTION.

Illustrated by MUYBRIDGE.

Published by LEWIS & CLARK, 157 Broadway, N.Y.

“GALLOP BARDNER,” owned by LELAND STANFORD, running at 4:14 3/4 over the Palo Alto track, 10th June, 1878.

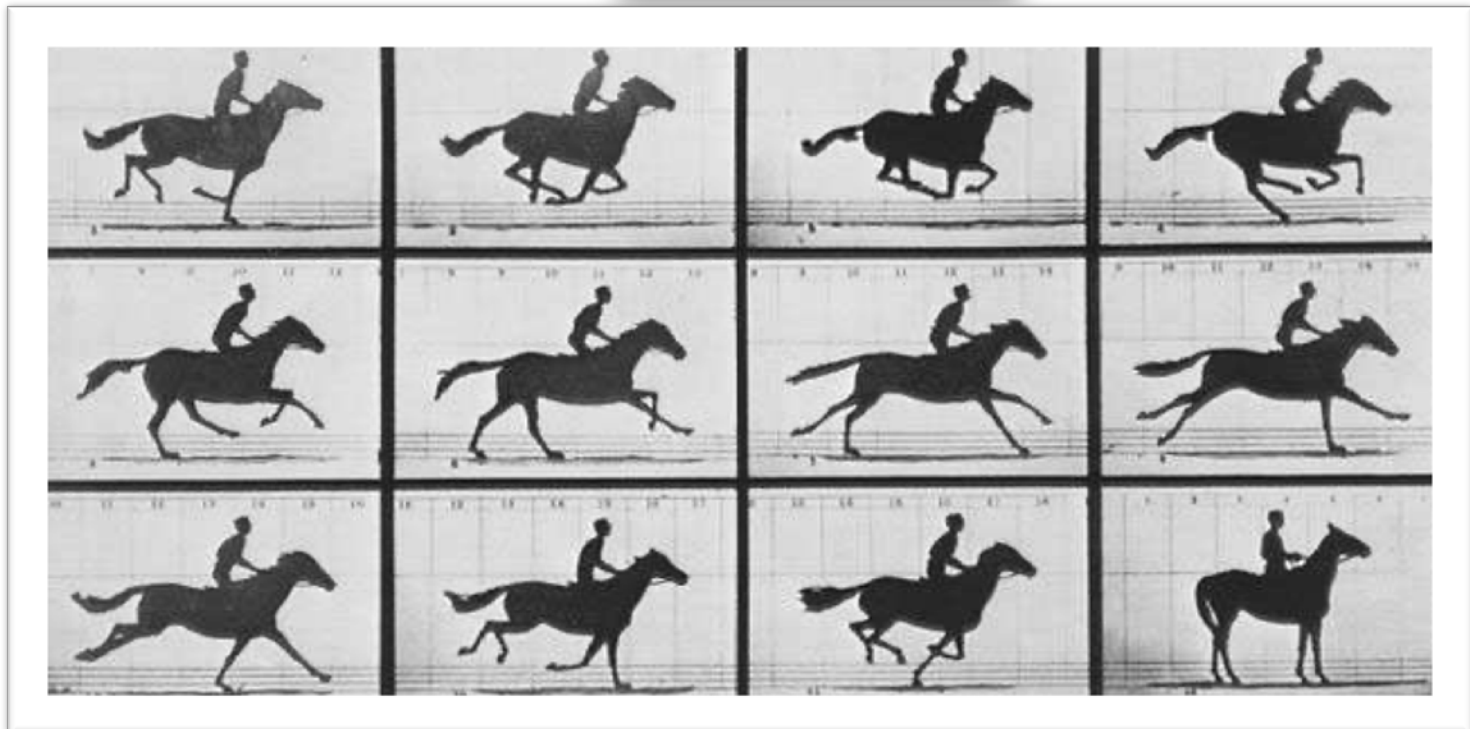

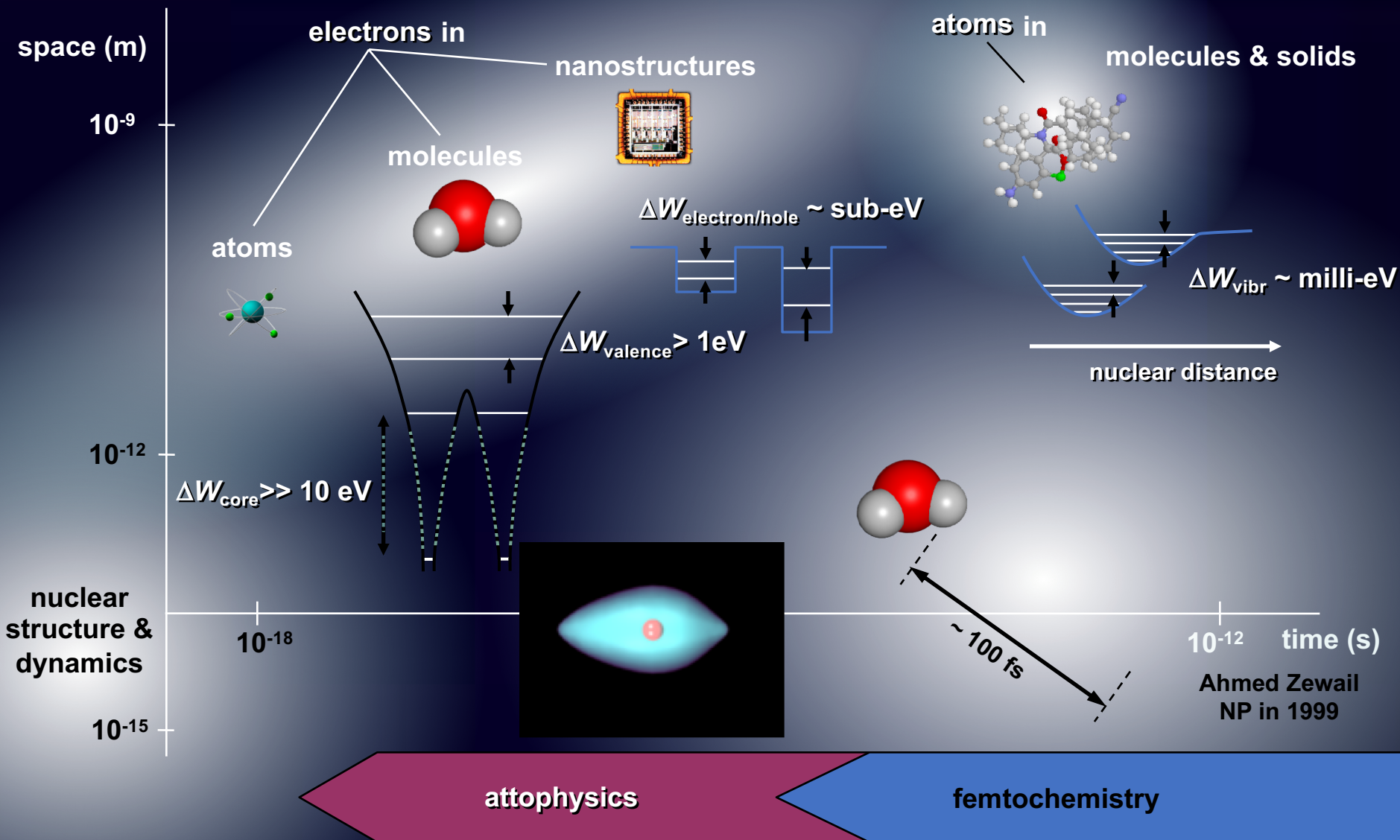

Time scale of electron motion

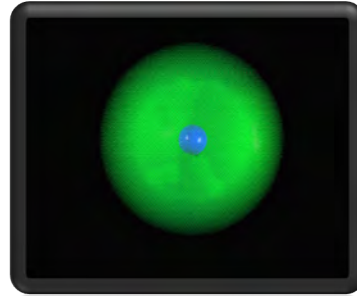
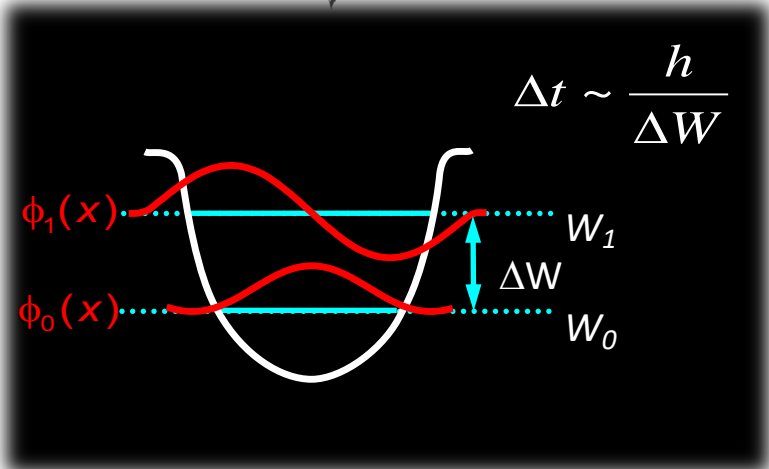

1S-2S quantum H atom (300 as)

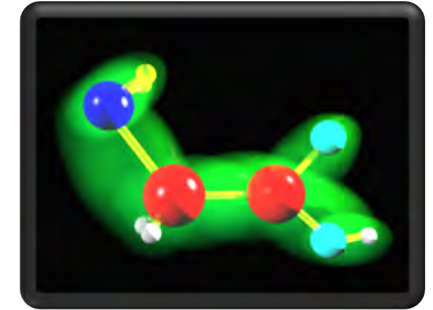

Charge migration in peptides (0.4-10 fs)

How brief are attoseconds??

- 1 second (s) = 10^0 s = 1 s
- 1 milisecond (s) = 10^{-3} s = 0.001 s
- 1 microsecond (s) = 10^{-6} s = 0.000001 s
- 1 nanosecond (s) = 10^{-9} s = 0.000000001 s
- 1 picosecond (s) = 10^{-12} s = 0.000000000001 s
- 1 femtosecond (s) = 10^{-15} s = 0.000000000000001 s
- 1 attosecond (s) = 10^{-18} s = 0.000000000000000001 s

00:01

**One attosecond is to one second as
one second is to the age of the universe**



Electron motion in our life!

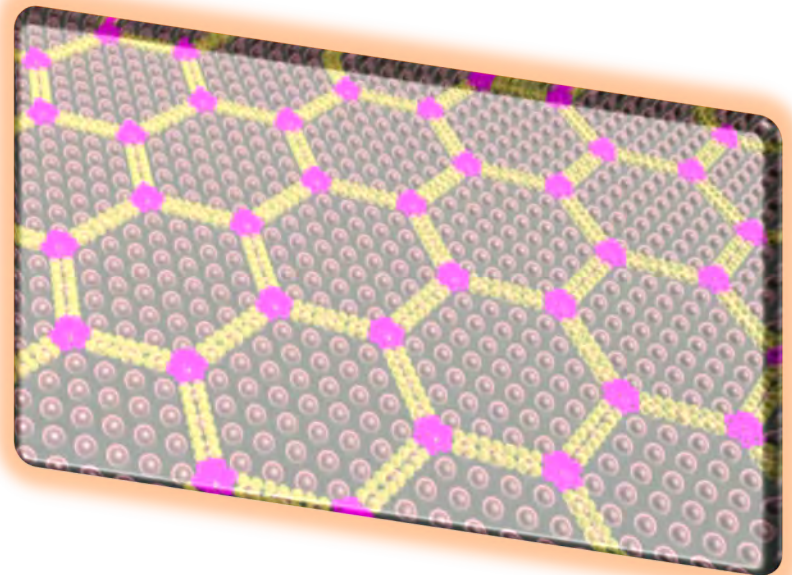
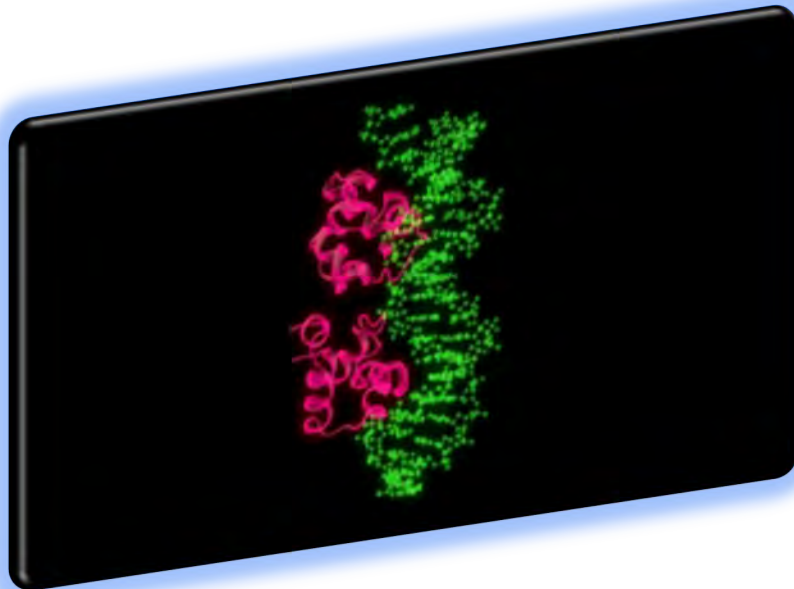

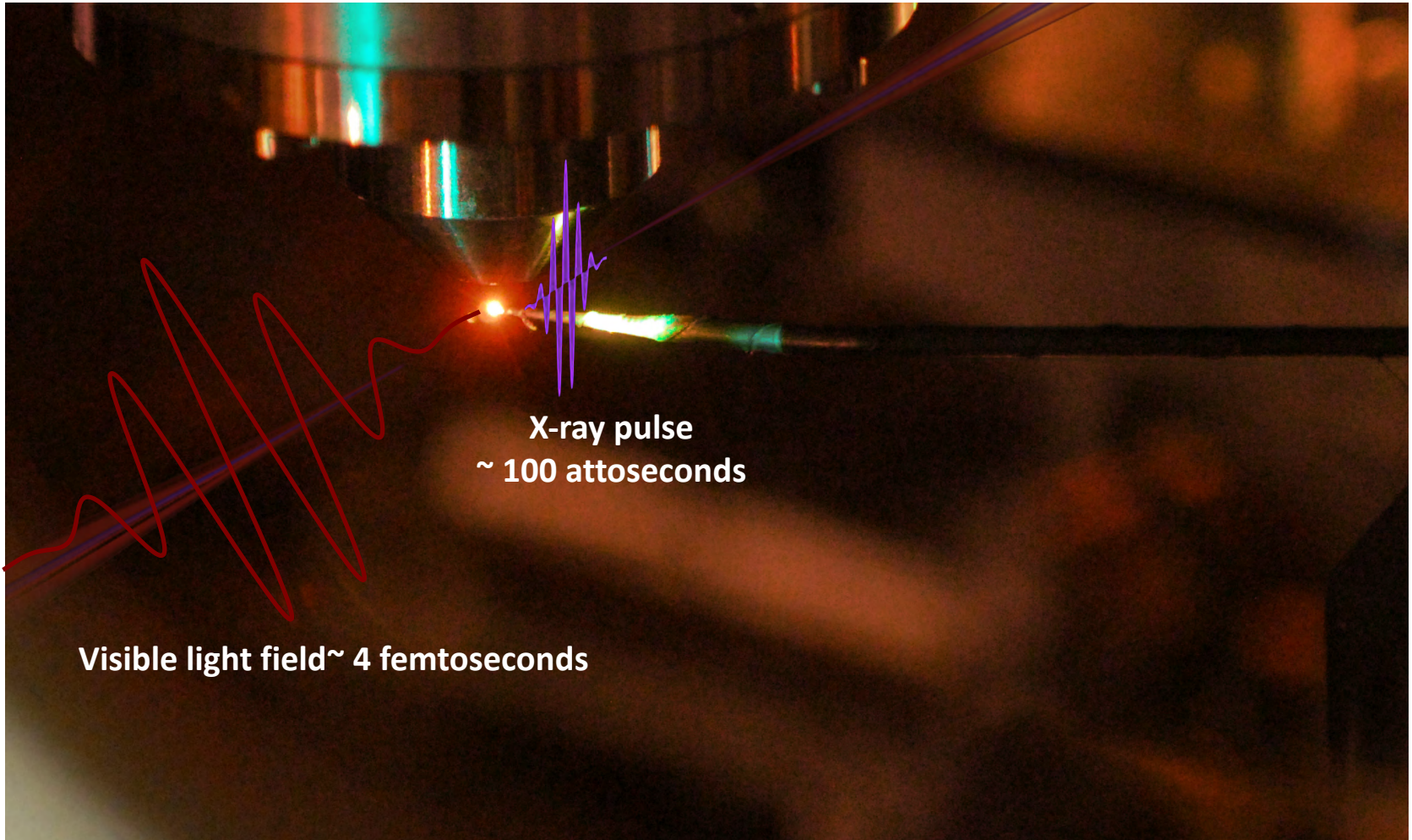



Scientific Background on the Nobel Prize in Physics 2018

GROUNDBREAKING INVENTIONS IN LASER PHYSICS

OPTICAL TWEEZERS AND GENERATION OF HIGH-INTENSITY,
ULTRA-SHORT OPTICAL PULSES

The Nobel Committee for Physics

However beautiful, the femtosecond laser technology developed during the 1960s, 1970s and 1980s was unable to break the 1-fs-pulse-duration limit. Shortly after the first experimental realisations of high harmonics, it was suggested that, in analogy with mode locking, high-order harmonics could lead to pulses shorter than 1 fs [73]. A decade later, after building on many improvements and insights into HHG by means of CPA-based lasers, the first attosecond pulses were experimentally observed [74, 75]. This was the birth of a new research field – attosecond science. For the first time, the electron dynamics inside atoms, molecules and matter in the condensed phase could be probed [76].

Attosecond tools gives an access to the electron dynamics in matter

- ❖ Few-cycle pulses provide the attosecond resolution to trigger electron dynamics in strong-field interaction and ionized systems.
- ❖ EUV pulses probe the electron dynamics in time-resolved spectroscopic measurements.

Limitations of the current tools;

1. Neutral systems
2. Molecular systems
3. Complex electronic systems
4. The dynamics in Space and time domains together
5. Limited electron motion control

- Few-cycle to single-cycle pulses

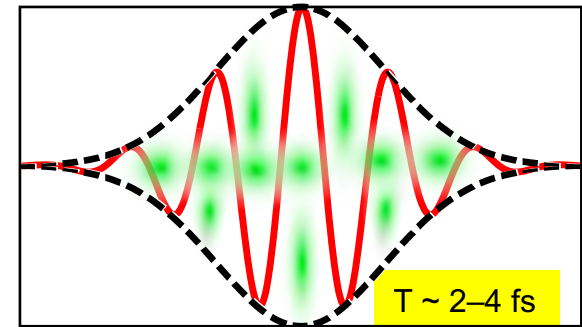

Ionization →

- Extreme UV attosecond pulses

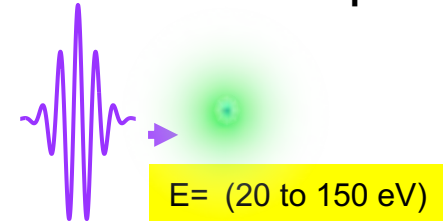

- ❖ The field calls for a *paradigm shift* tools to trigger, control and image the electron dynamics in matter;
- **Synthesized Attosecond Laser Pulse (ALP)**
- **Attosecond Electron Pulse (AEP)**

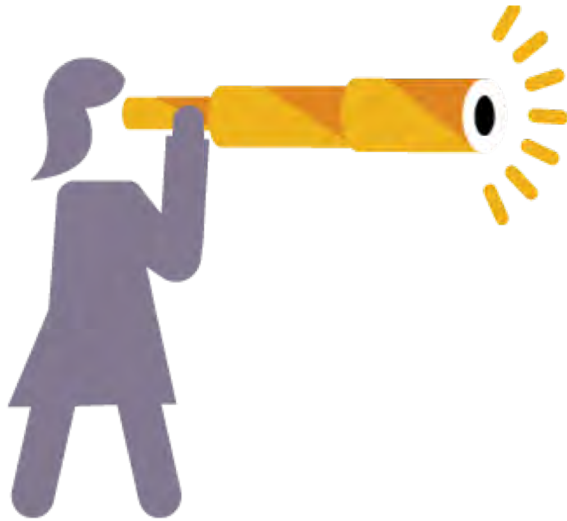

These tools will allow to develop:

- ❖ **Attosecond Electron Diffraction** and
- ❖ **Attosecond Electron Microscopy “Attomicroscopy”**
- ❖ **fine control the electron motion in its native time scale.**

which will take the whole field to the next level by permit, for the first time, directly image and record “movies” the electron motion in action.

We can only control
what we can see

Imaging and record movies of electron motion in action and its control on its native time scale promises to break new ground in science and technology

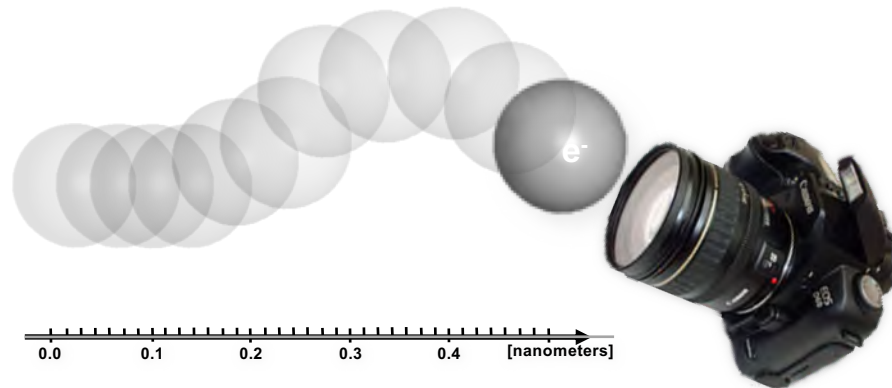

I- Attosecond electron motion control

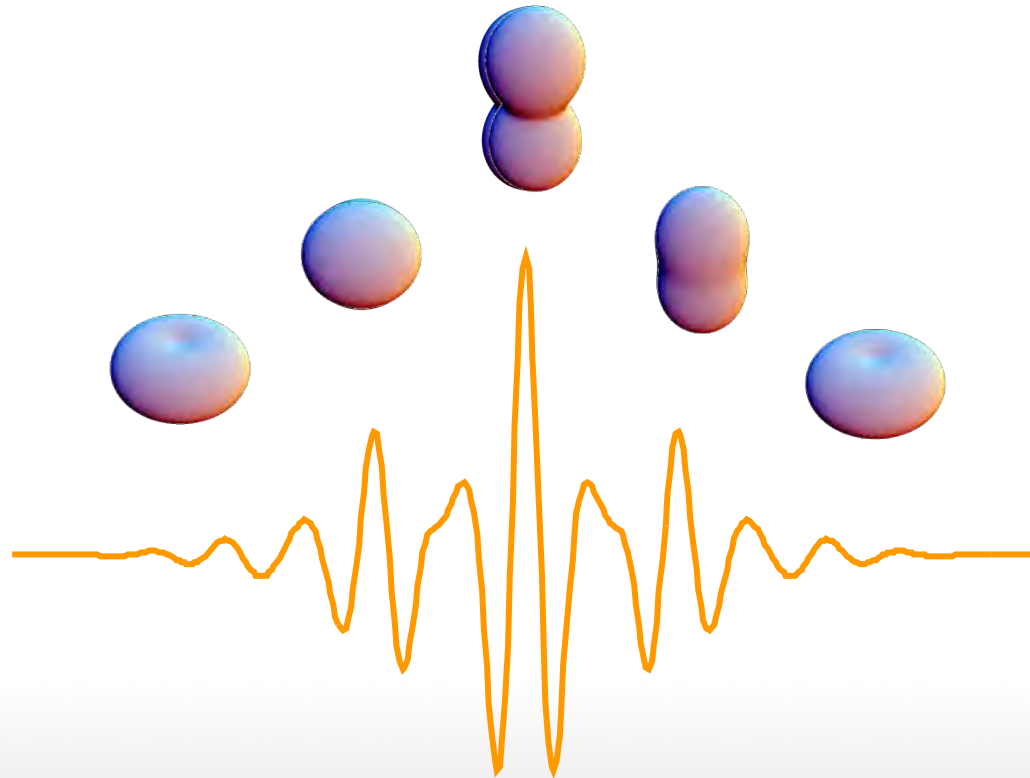

M. Hassan *et. al.*, Rev. Sci. Instr. 83,11, (2012).

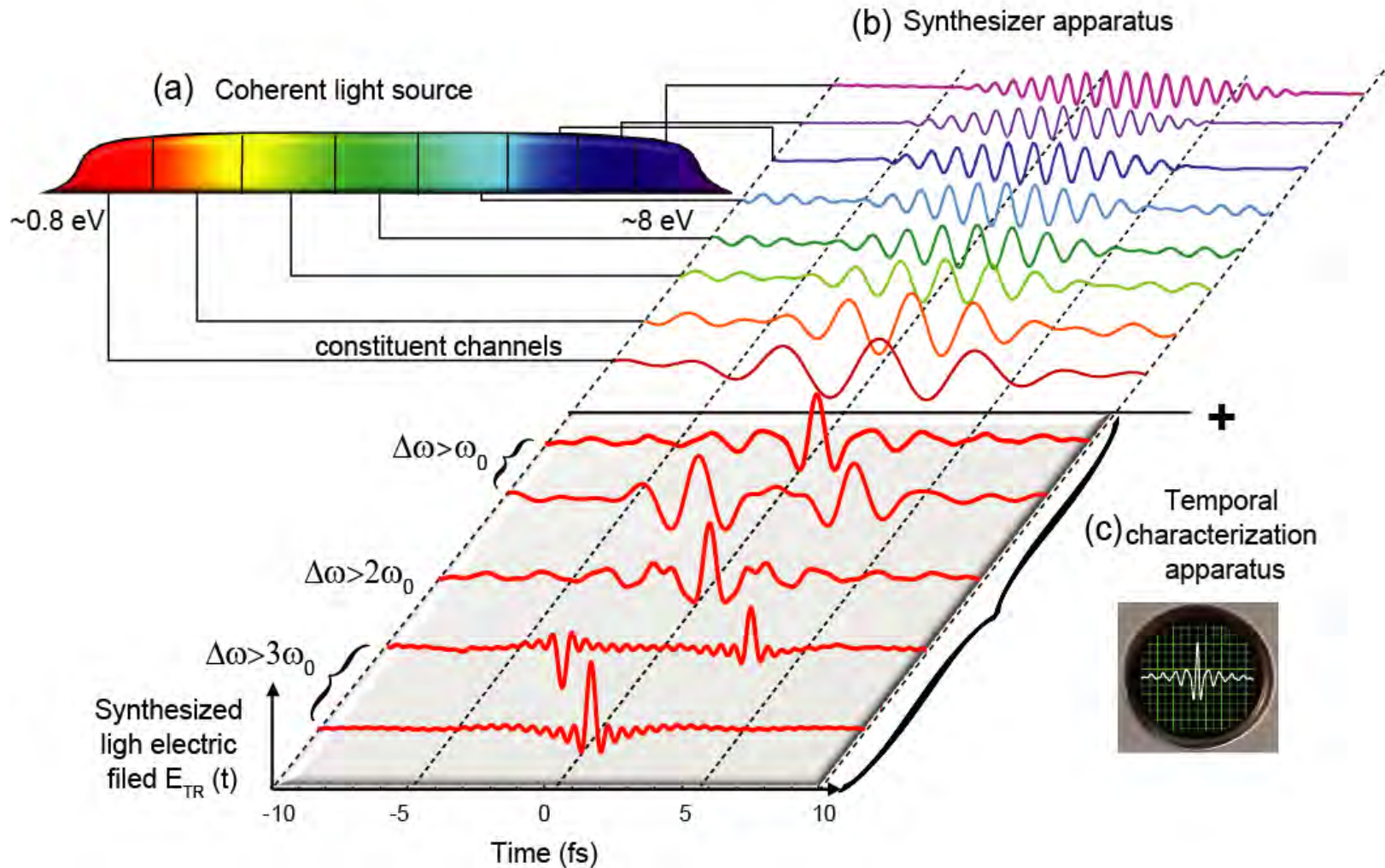

Generation of the broadest supercontinuum spans more than 2-octaves

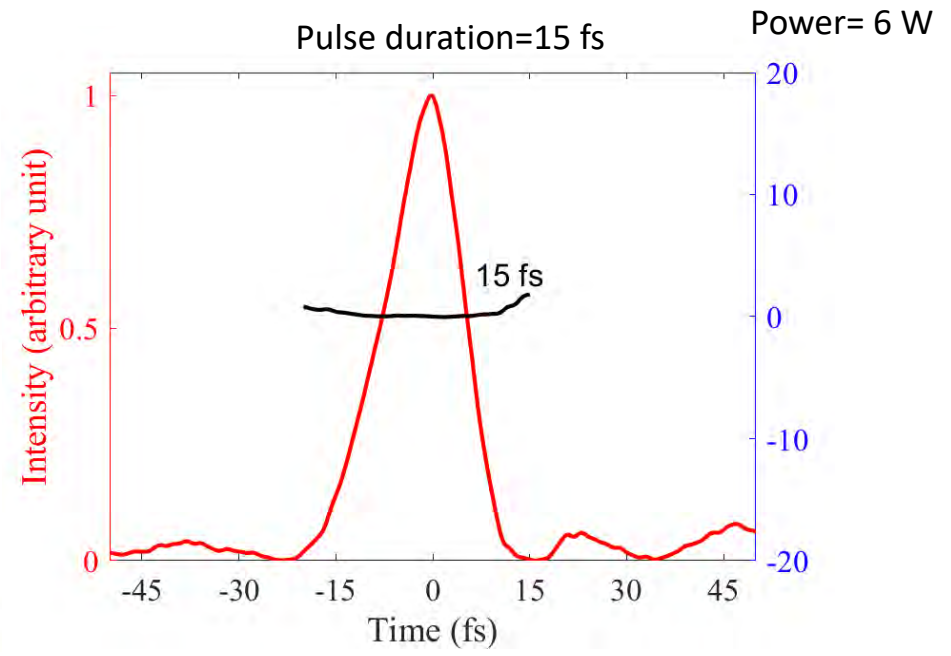
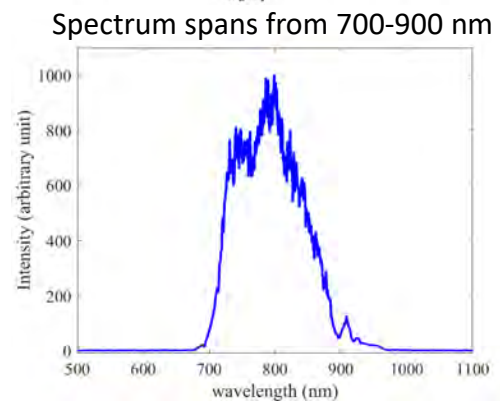
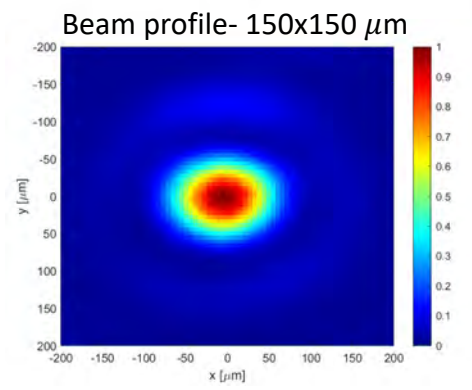
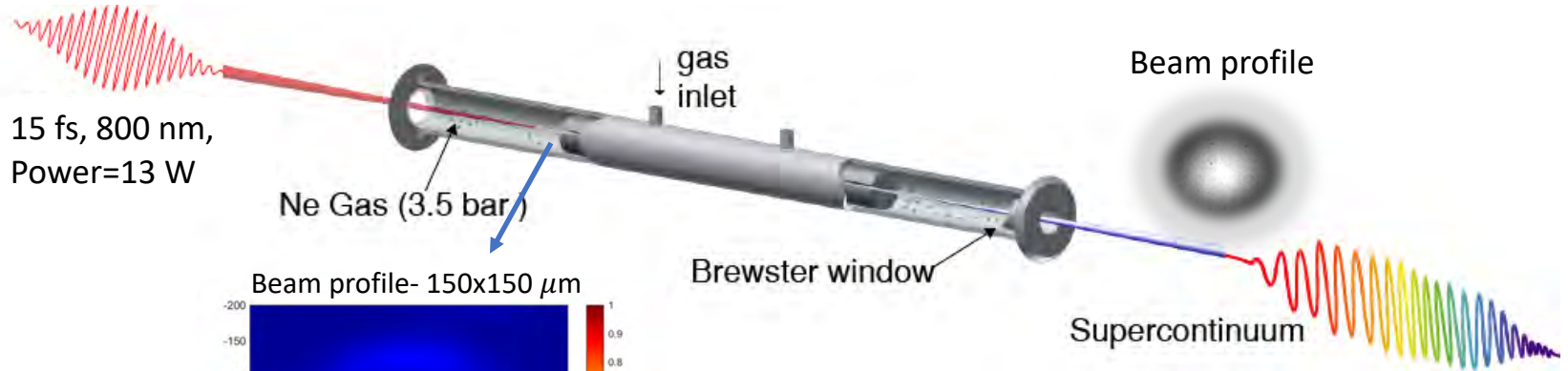

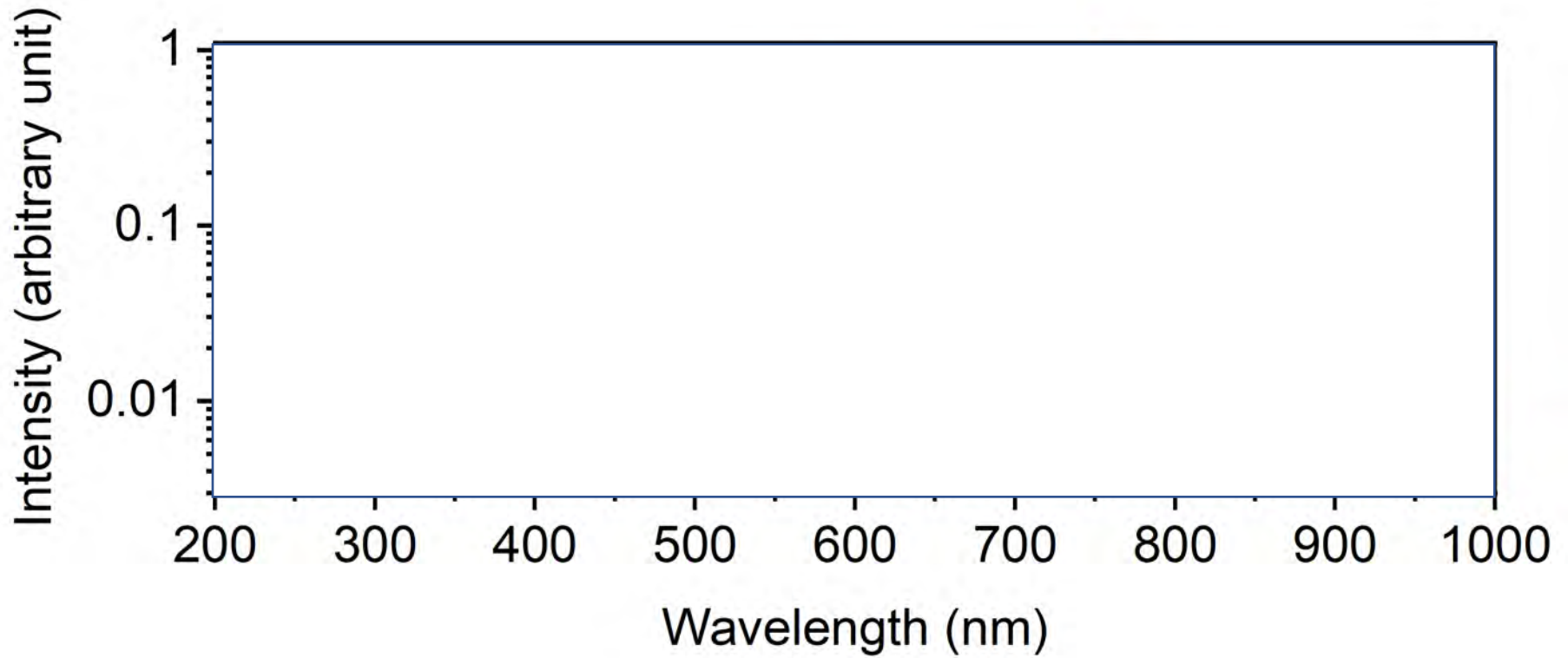

Light Field Synthesizer in action



Light Field synthesizer in action



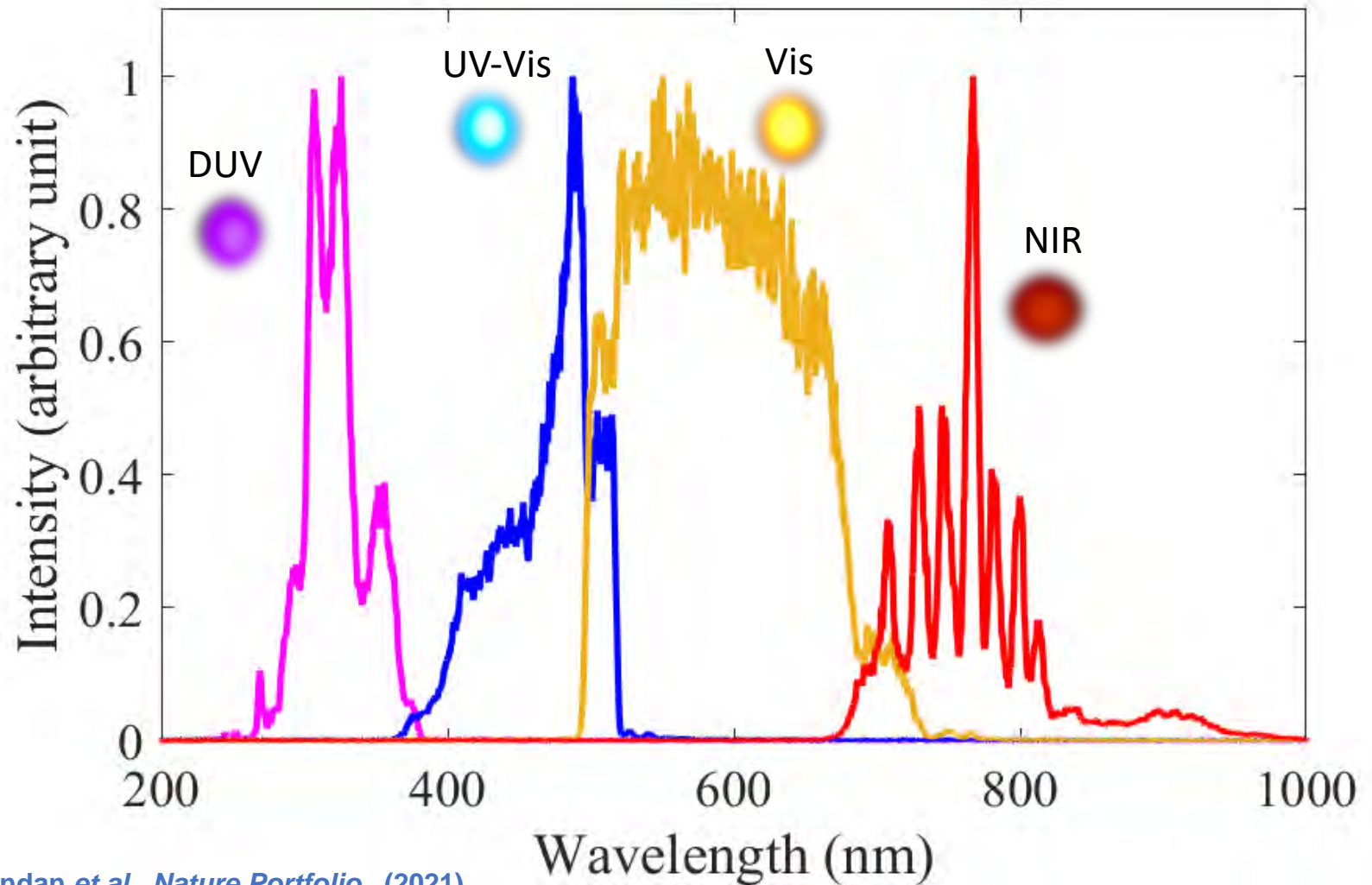

H. Dandan et al., *Nature Portfolio*, (2021).

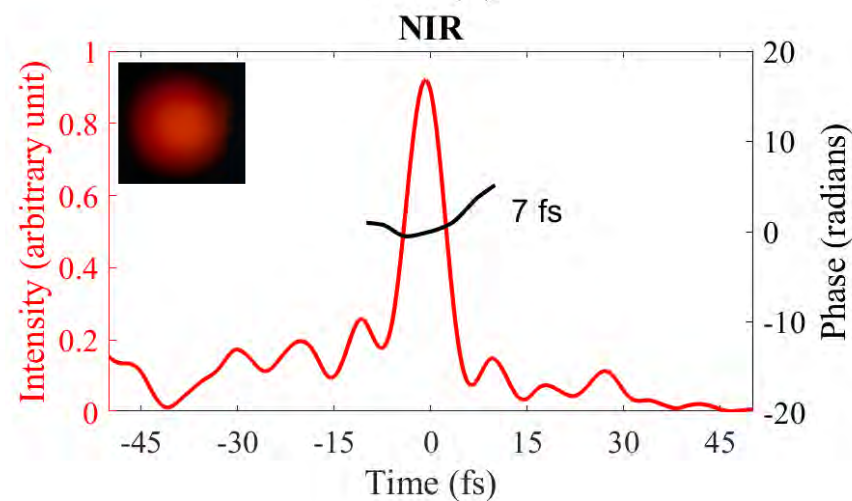
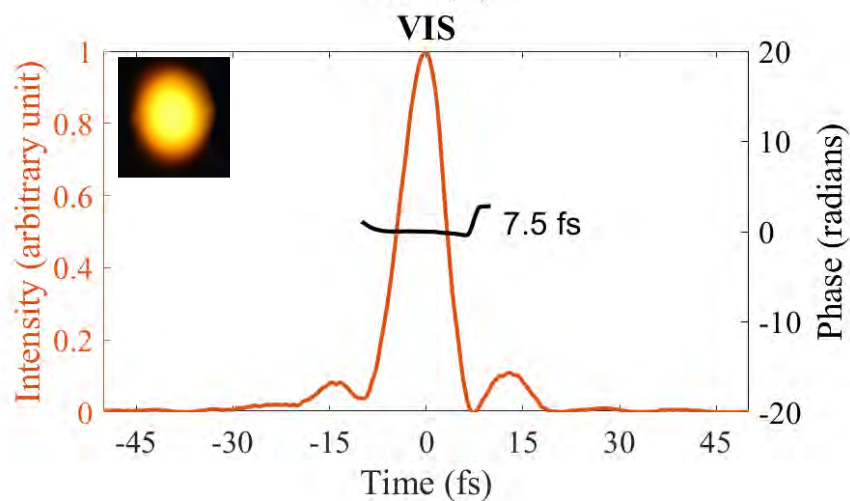
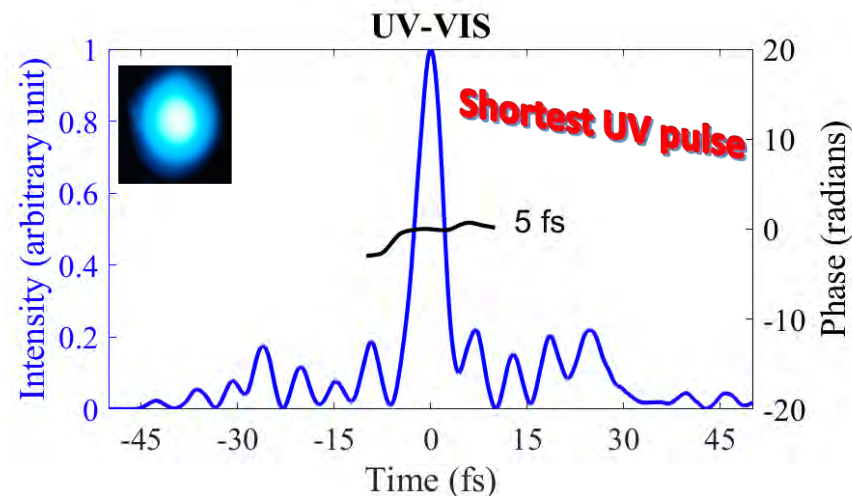
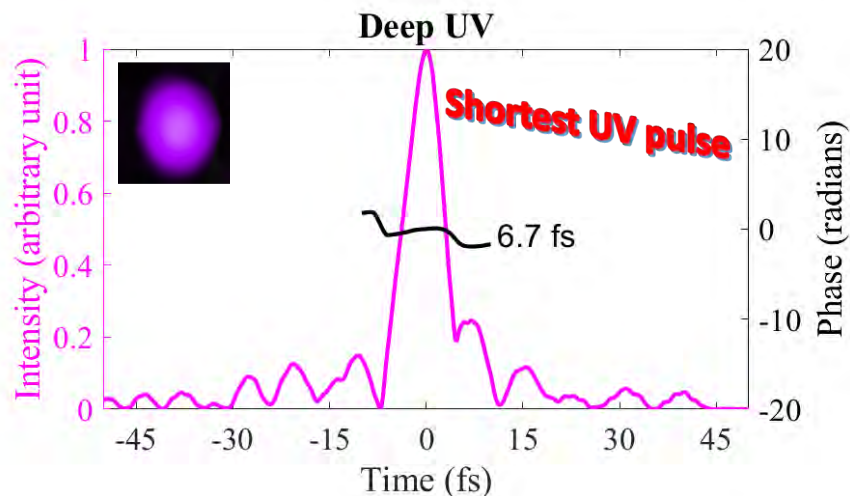

All-Optical light field sampling

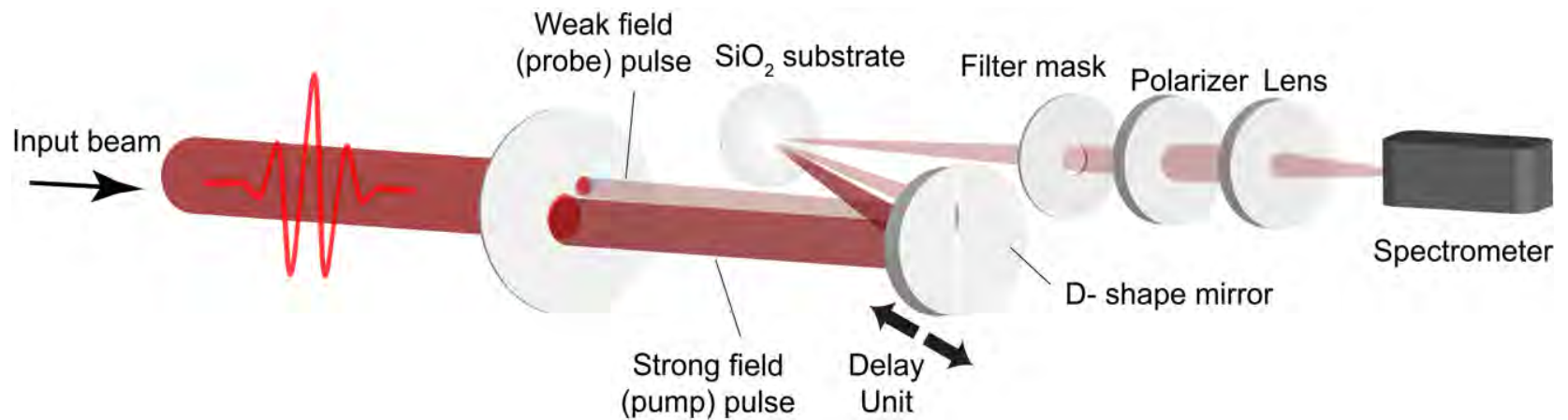
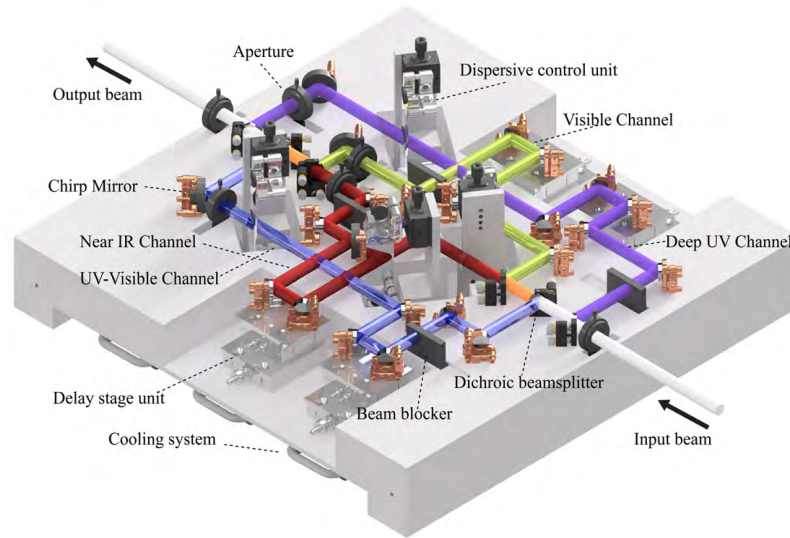

H. Dandan *et al.*, *Nature Portfolio*, (2021).

For more details please read Apalkov V & Stockman MI (2012) Theory of dielectric nanofilms in strong ultrafast optical fields. *Physical Review B* 86(16):165118.



The motion of an electron with 1D wave vector k , pointing along the direction of electric field, is described by the following equation

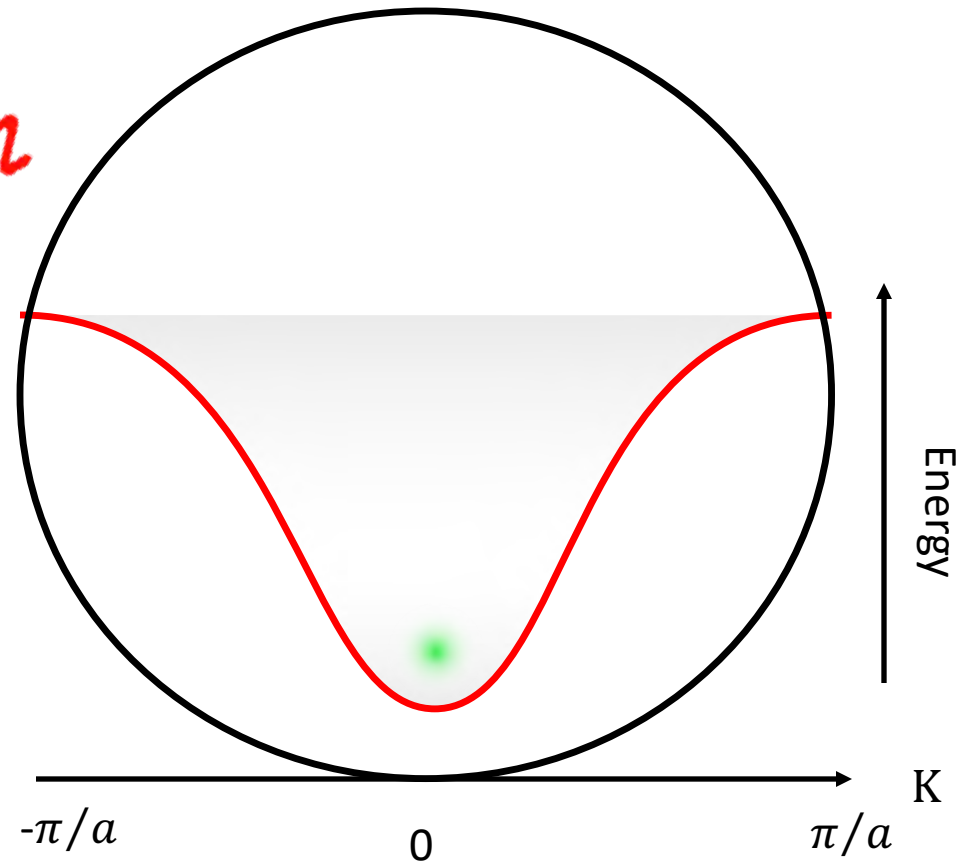

Schiffrin, A. et al. *Nature* **493**, 70, (2013).

All-Optical light field sampling

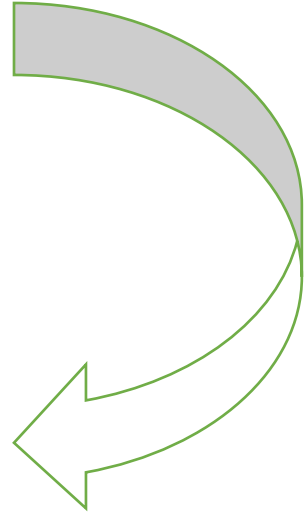
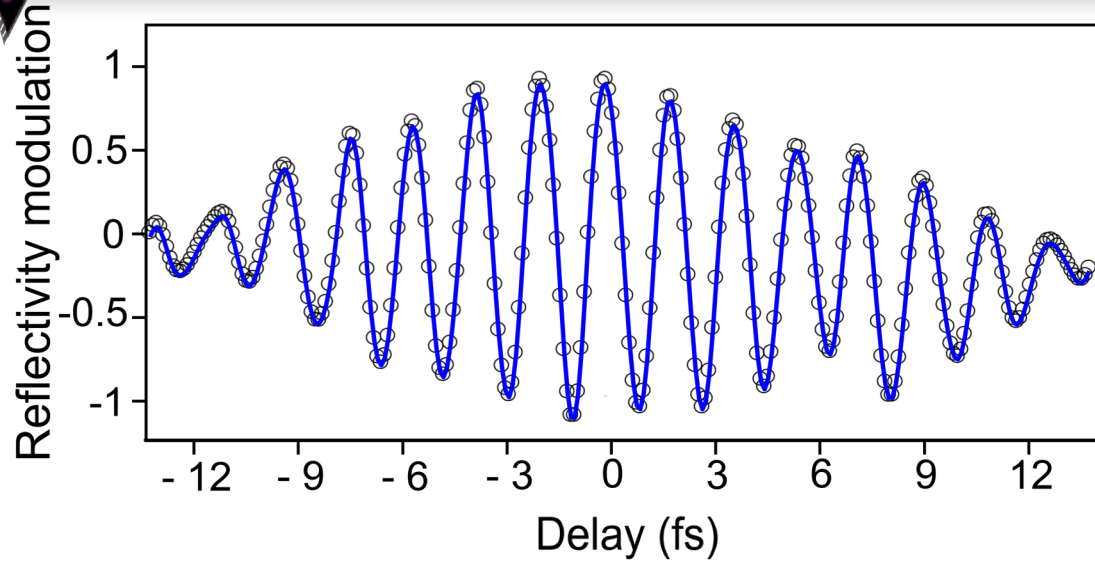

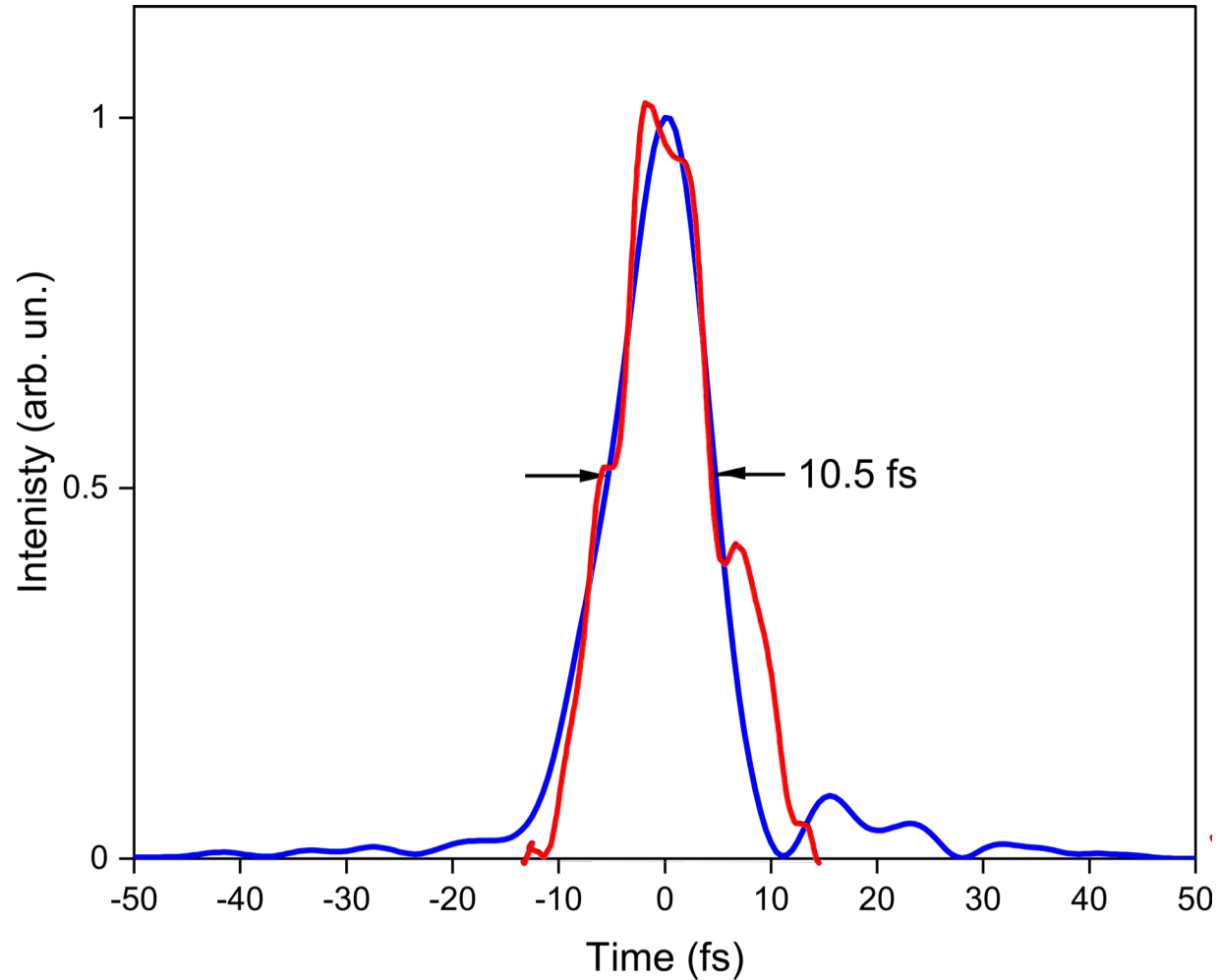

H. Dandan *et al.*, *Nature Portfolio*, (2021).

Field Synthesis



Feedback

Measurement

Analysis

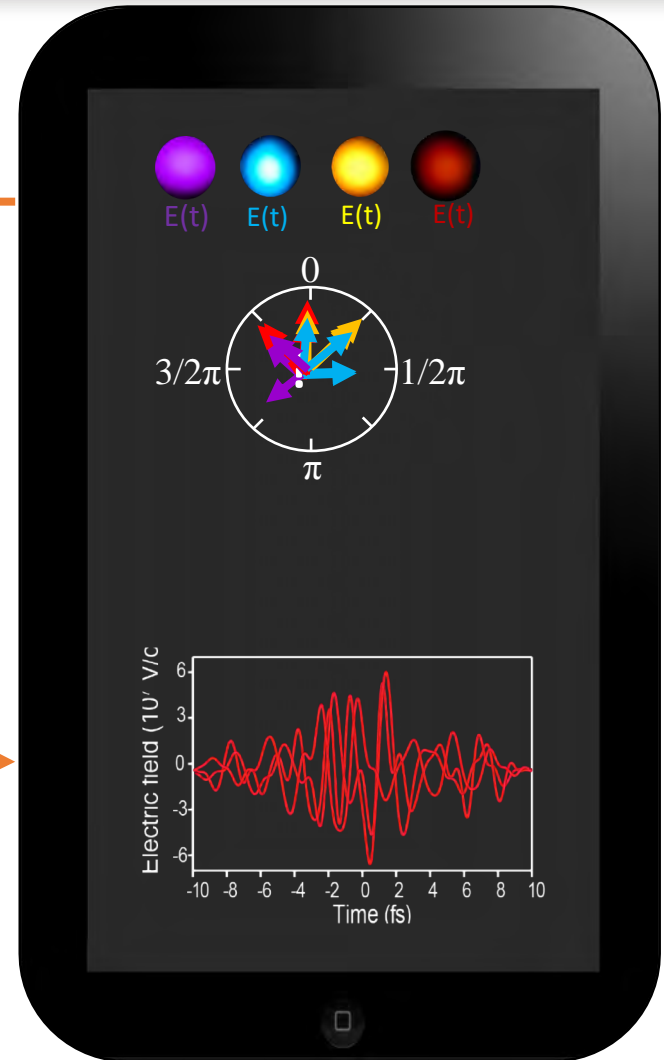

M. Th. Hassan et al., Rev. Sci. Instrum. 83, 111301 (2012).

M. Th. Hassan et al., Nature 530 (7588): 66-70 (2016)

H. Dandan et al., Nature Portfolio, (2021).

All-Optical light field sampling

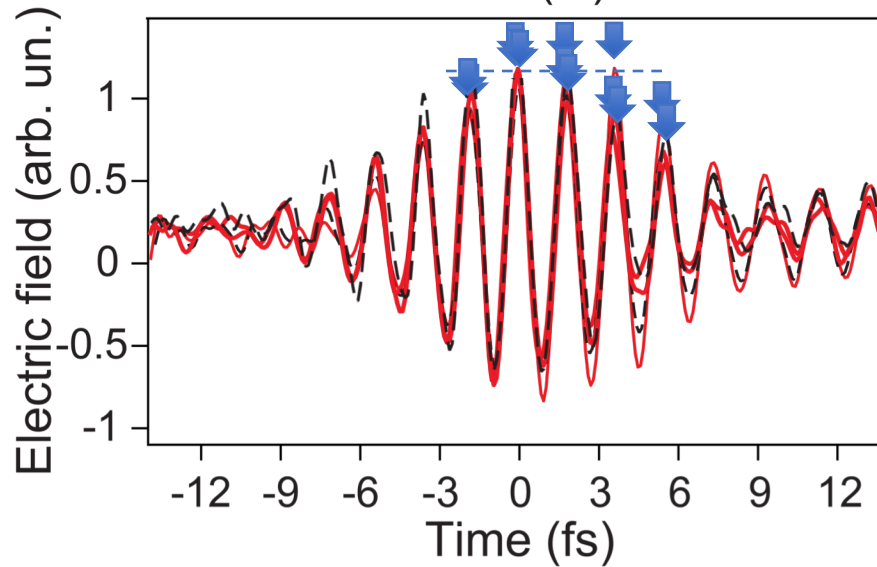
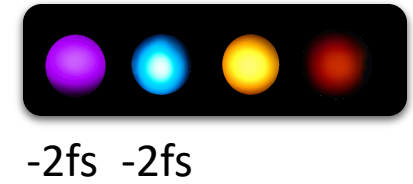
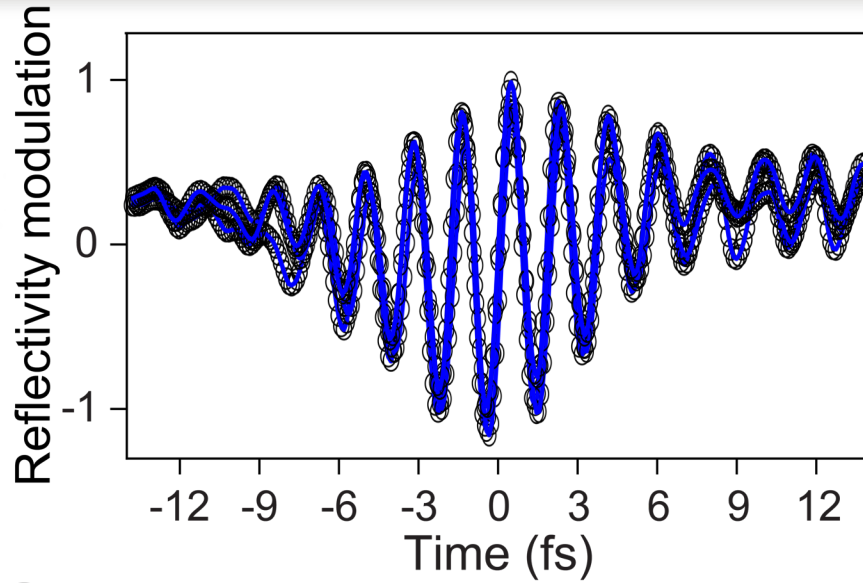
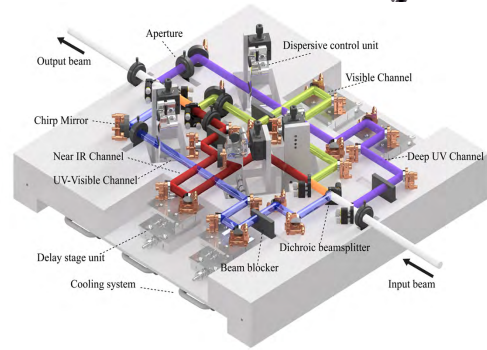

Optical attosecond pulses

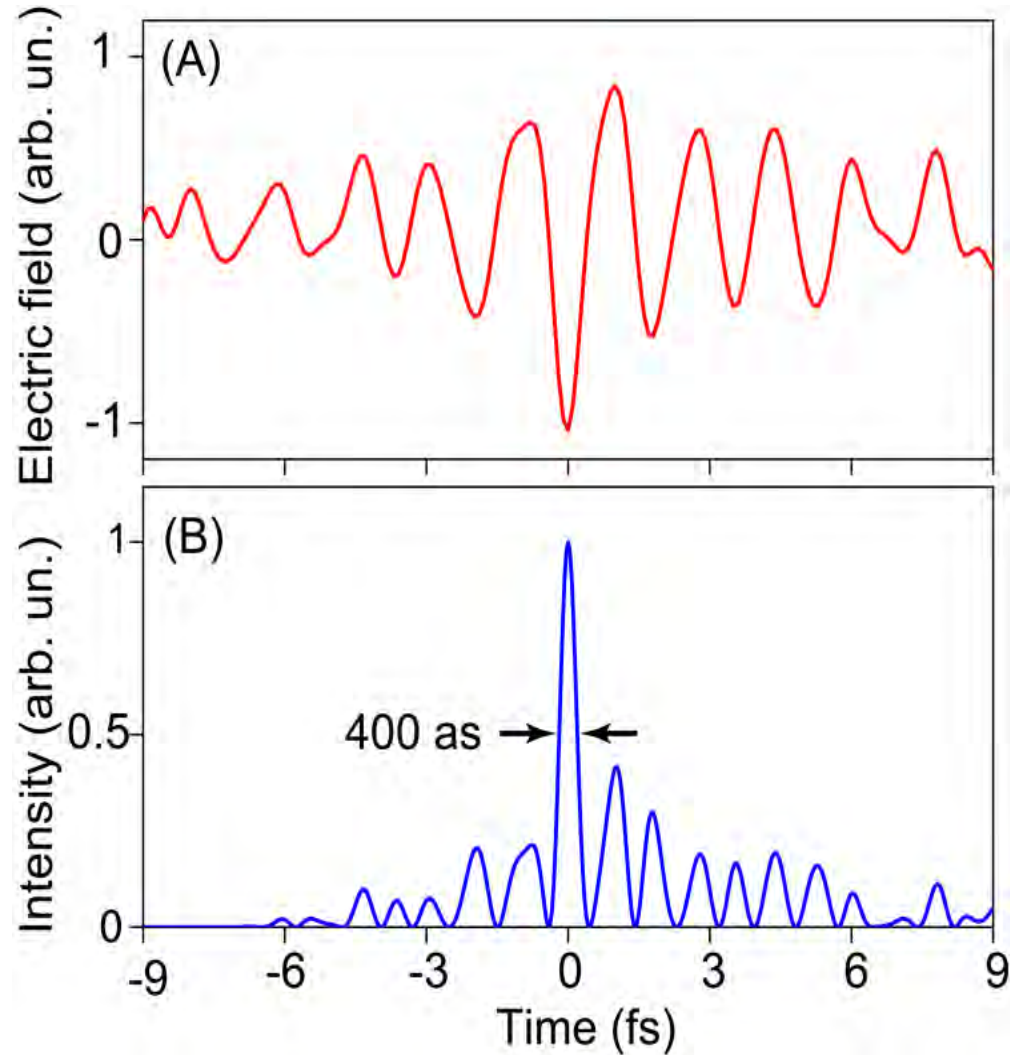

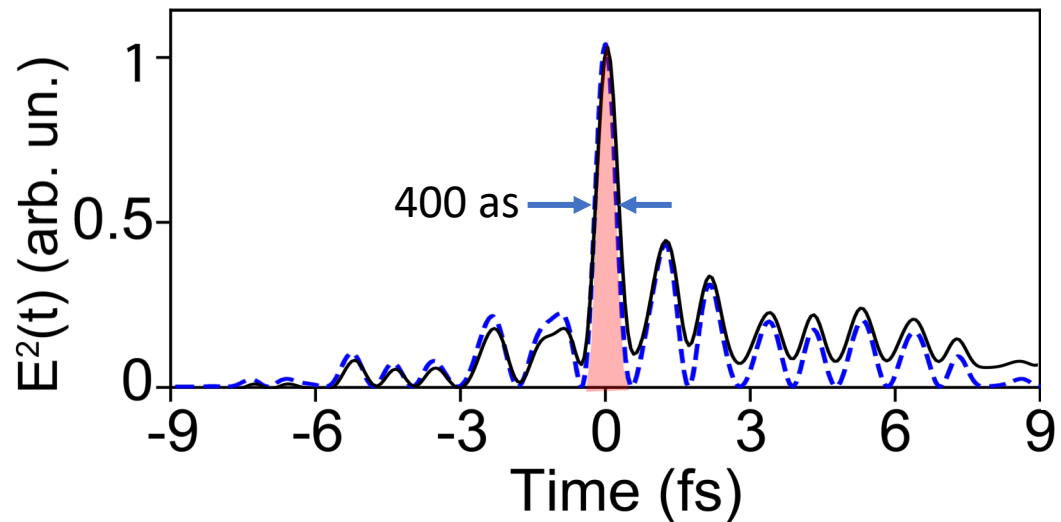
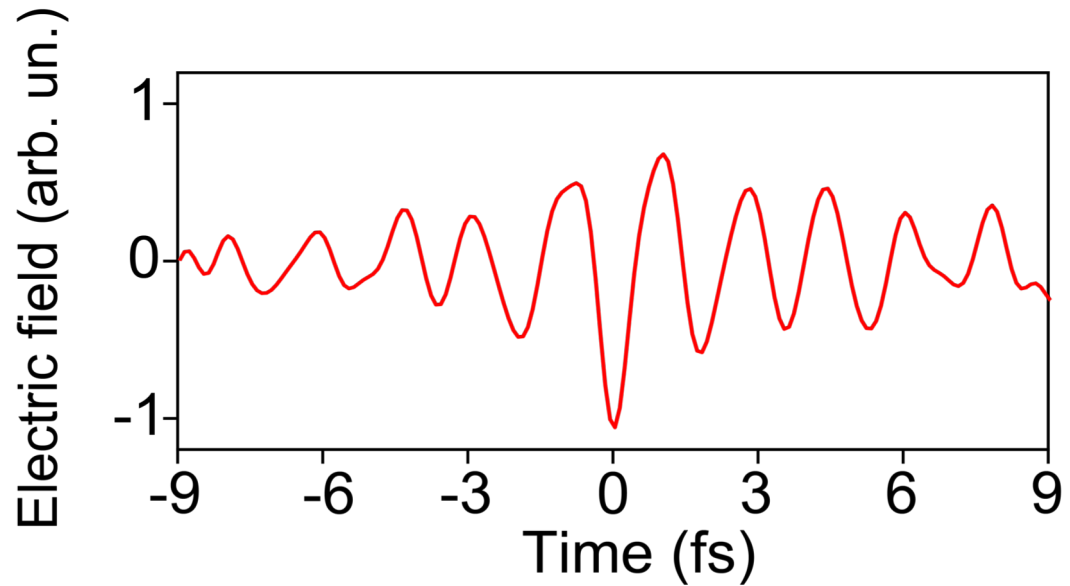

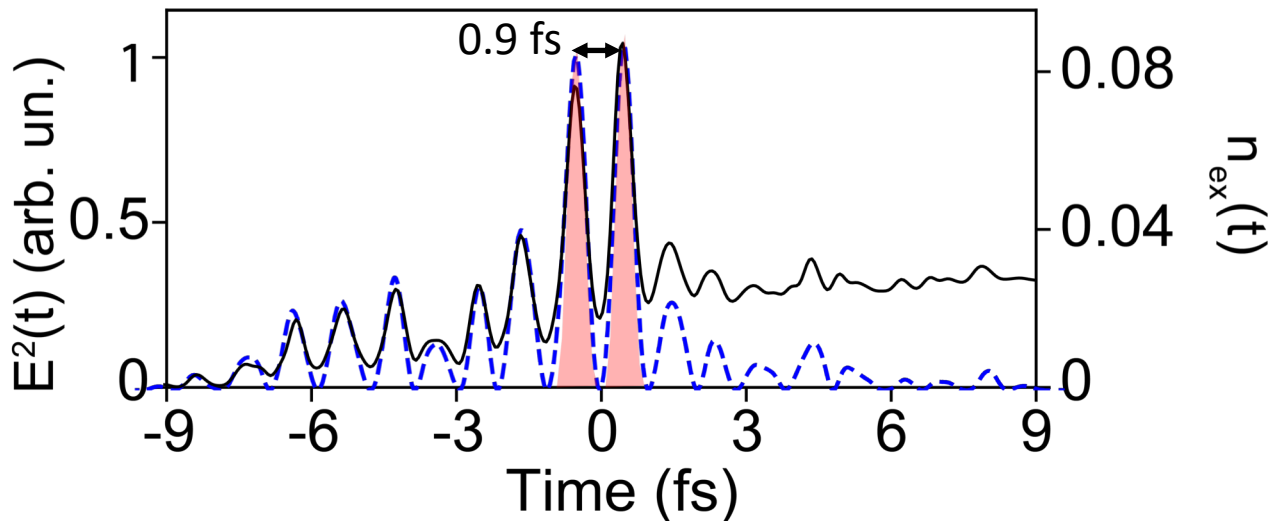
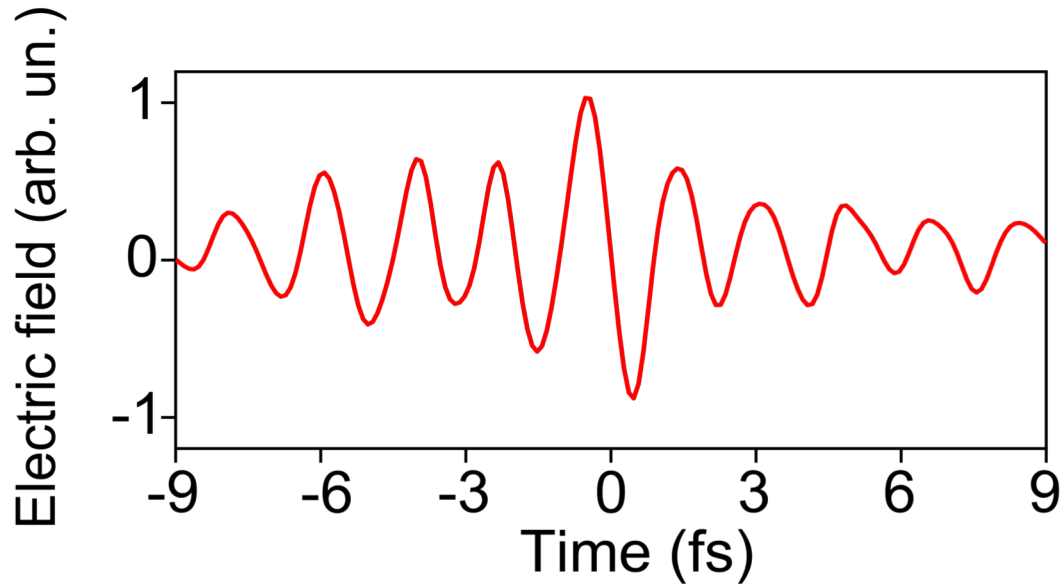

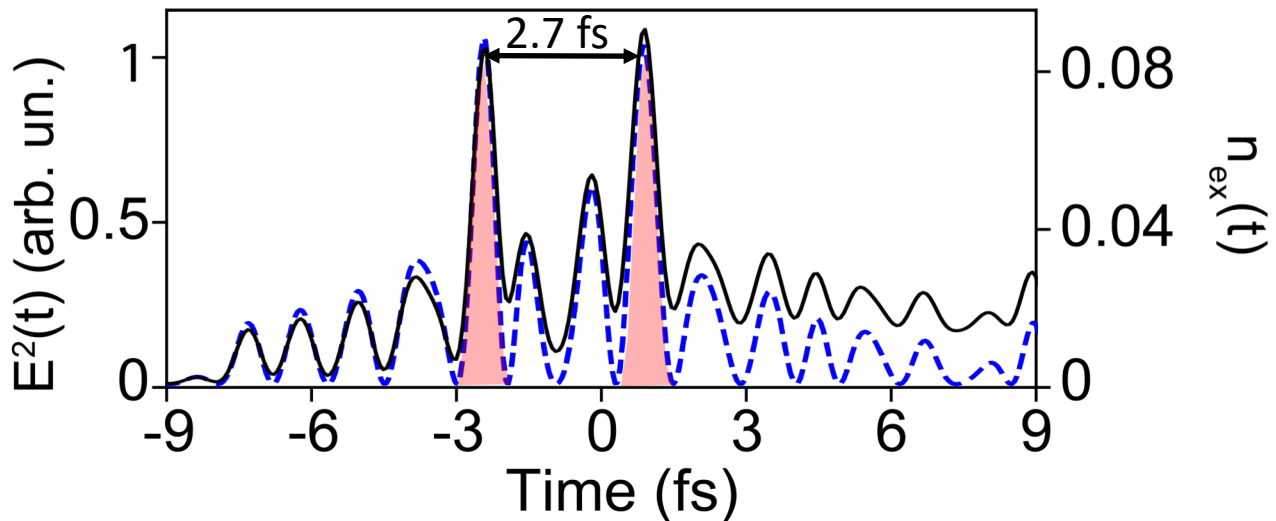
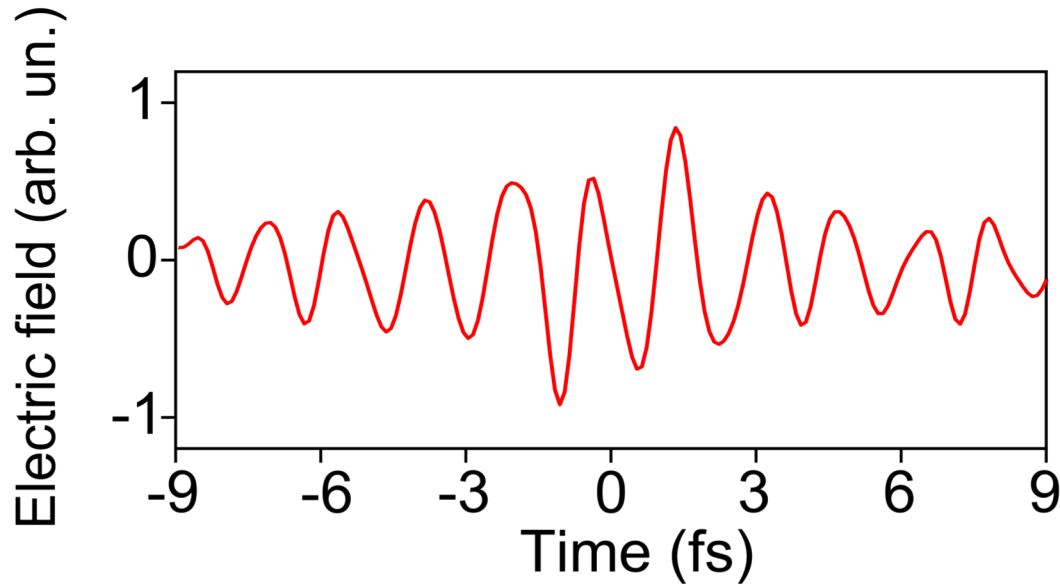

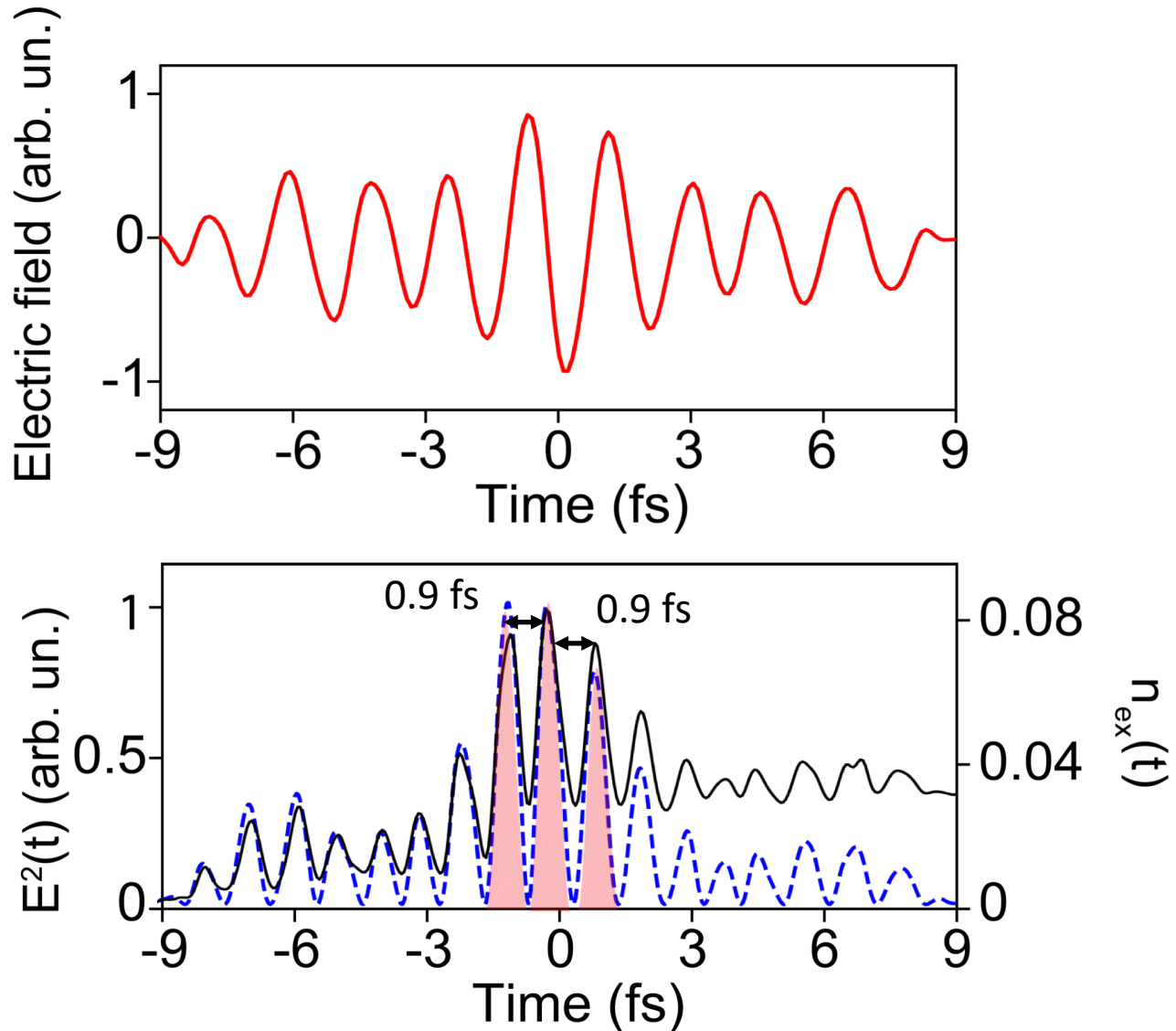

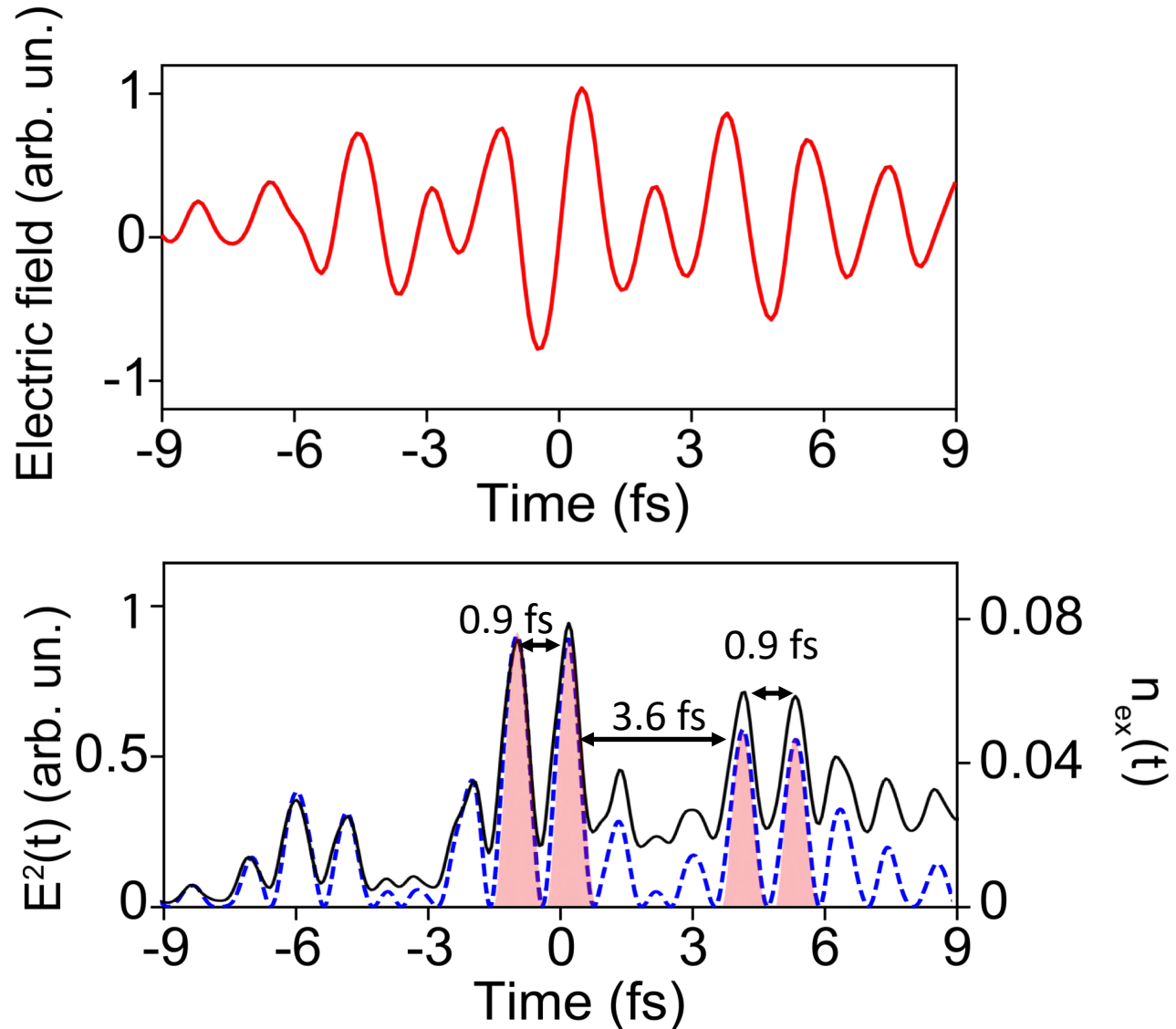

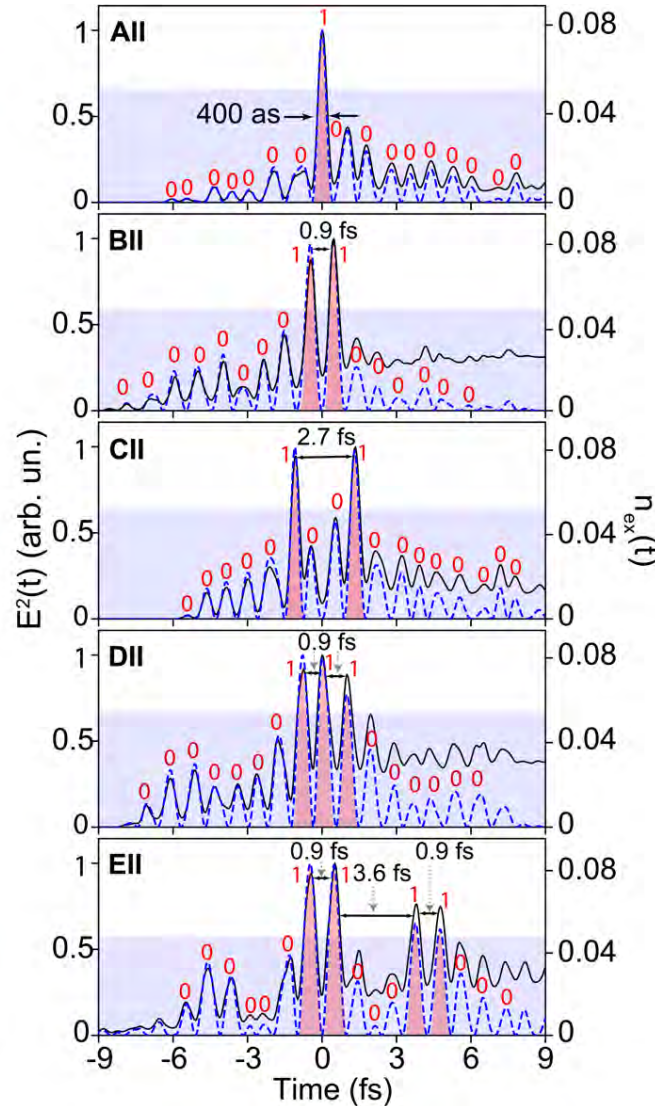
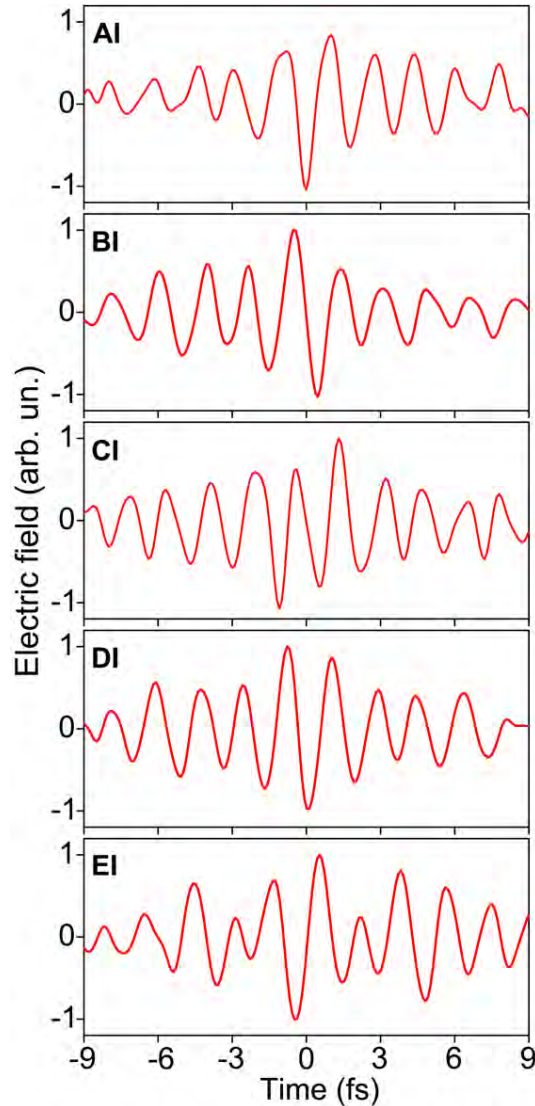

00 00 00 01 00 00 00 00

00 00 00 00 11 00 00 00

00 00 00 10 01 00 00 00

00 00 00 00 11 10 00 00

00 00 00 11 00 01 10 00

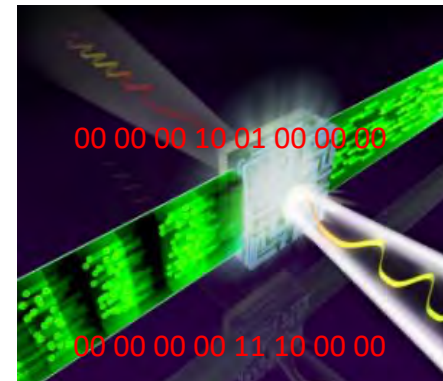

Nature Photon **8**, 214–218 (2014)

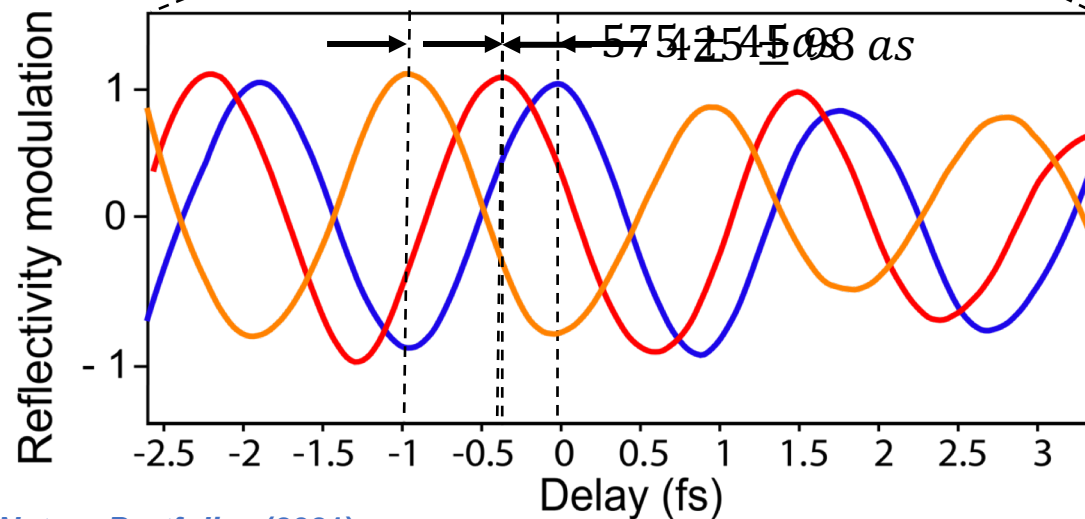
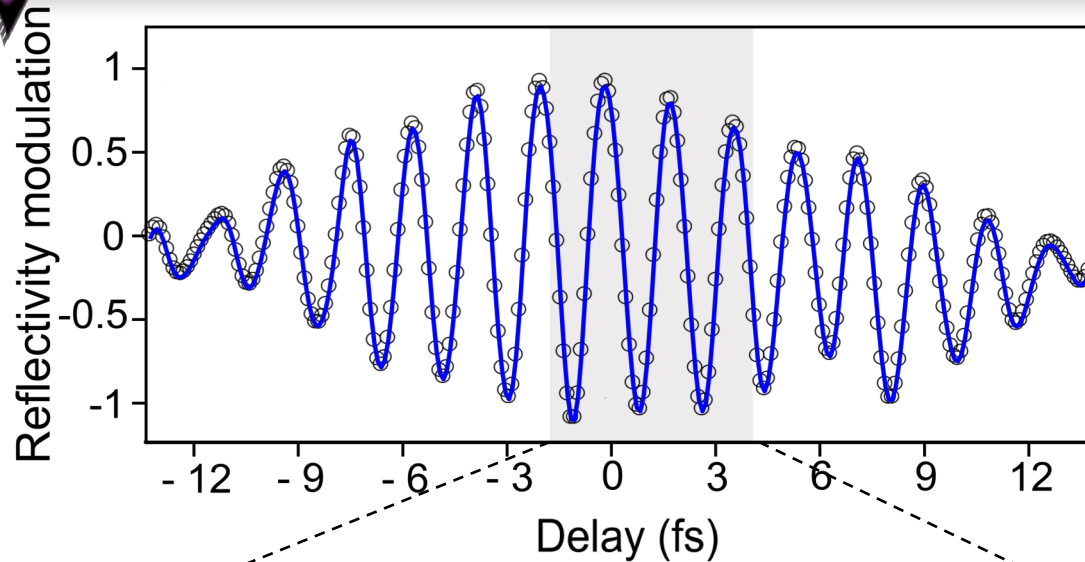

- $F_1=0.78 \text{ V/\AA}^\circ$
- $F_2=0.96 \text{ V/\AA}^\circ$
- $F_3=1.10 \text{ V/\AA}^\circ$

II- Attosecond electron motion imaging

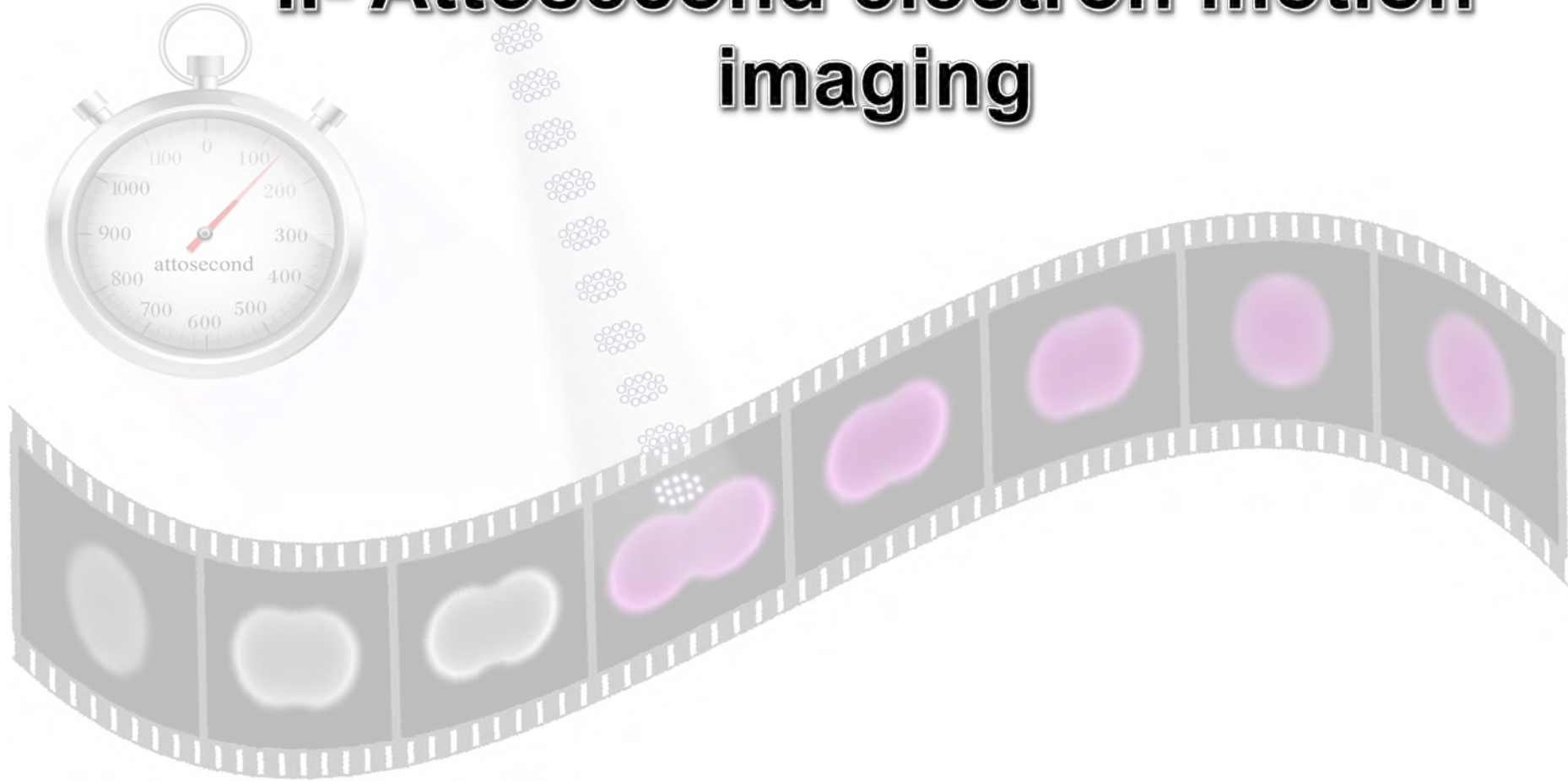

**Attosecond Electron Diffraction
and Microscopy “Attomicroscopy”**

Ultrafast Electron Microscopy

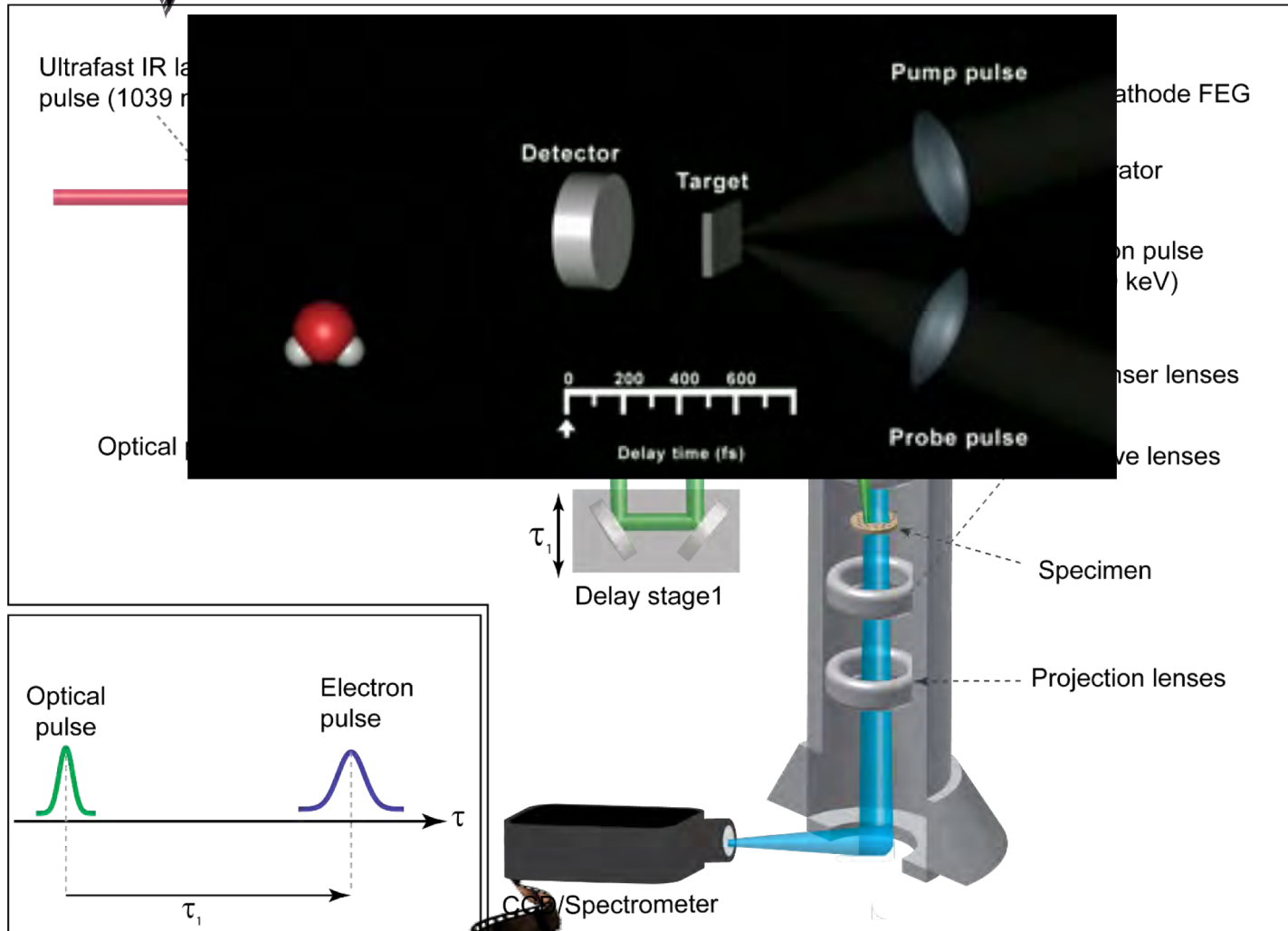

M. Th. Hassan, et al. "Attomicroscopy: imaging the electron motion in real time. *J. Phys. B: At. Mol. Opt. Phys.* 51, 032005 (2018).

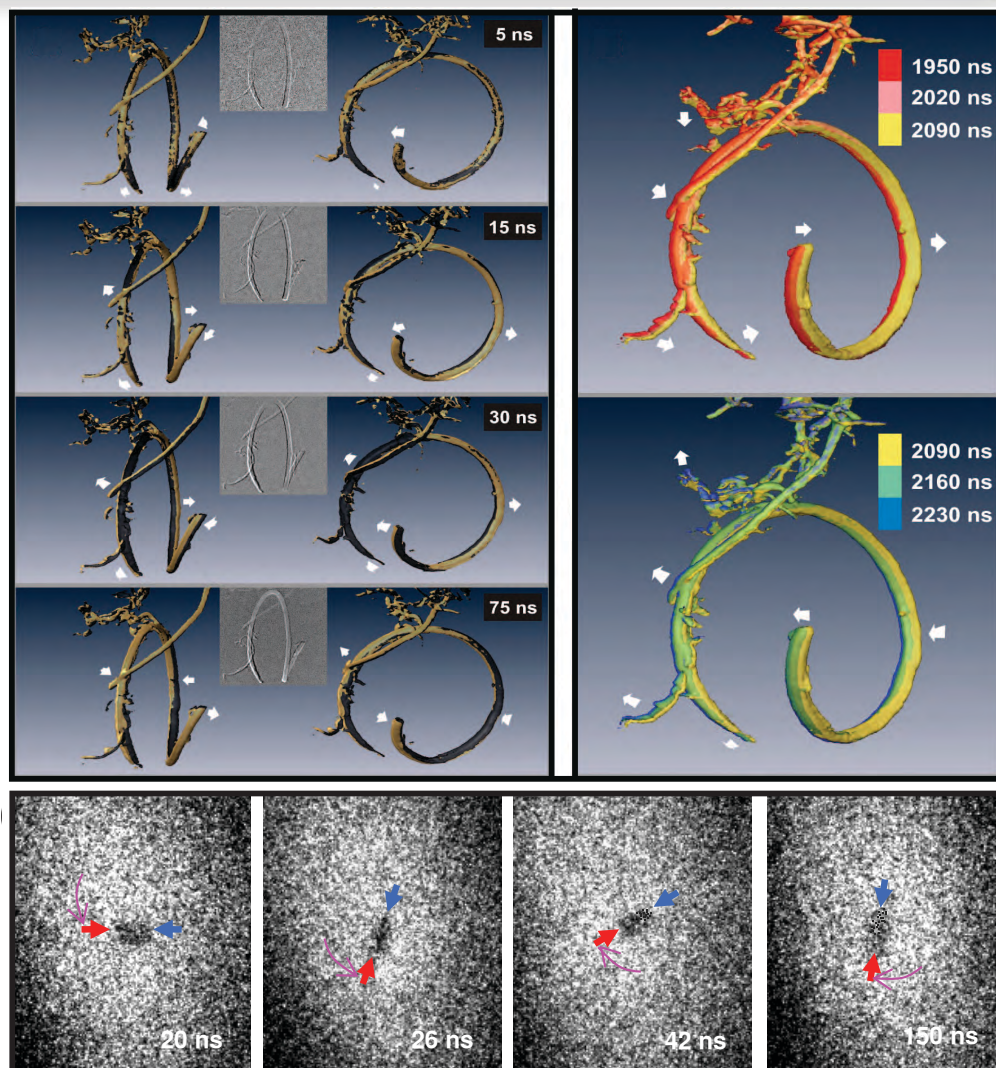
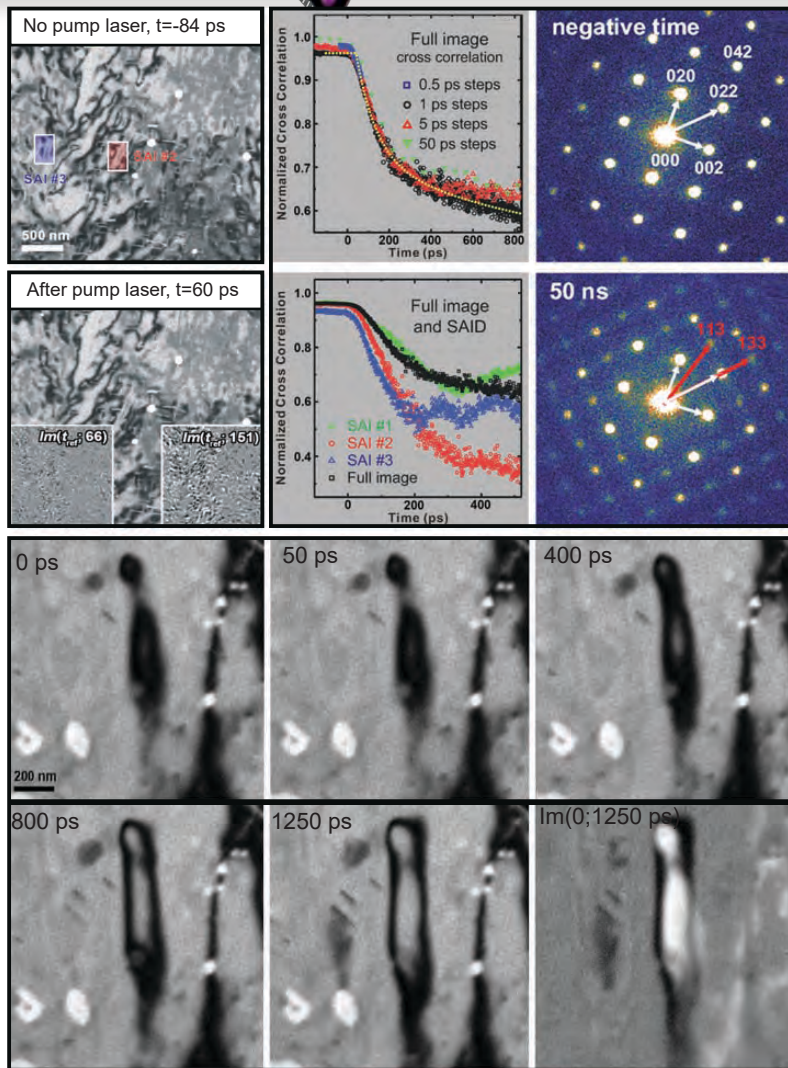

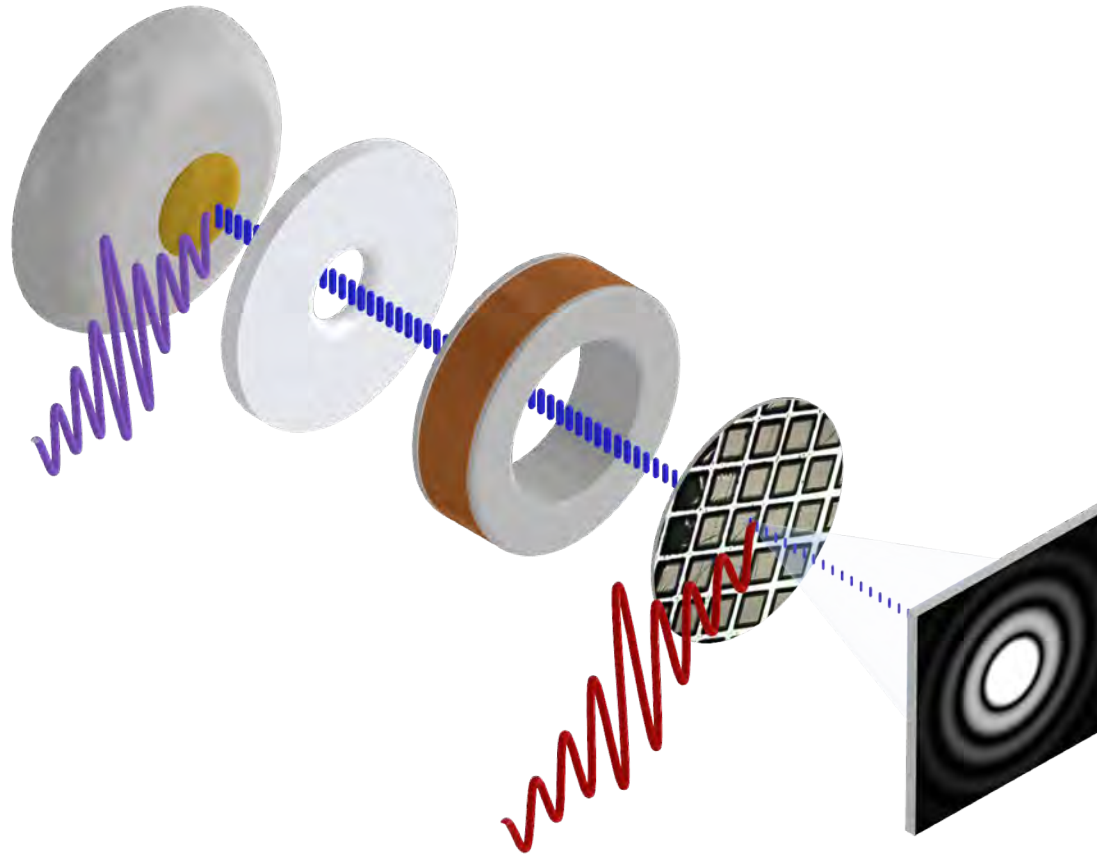

M. T. Hassan, Attomicroscopy: from femtosecond to attosecond electron microscopy. *J. Phys. B: At. Mol. Opt. Phys.* 51, 032005 (2018).

RF compression scheme of ultrafast electron pulse

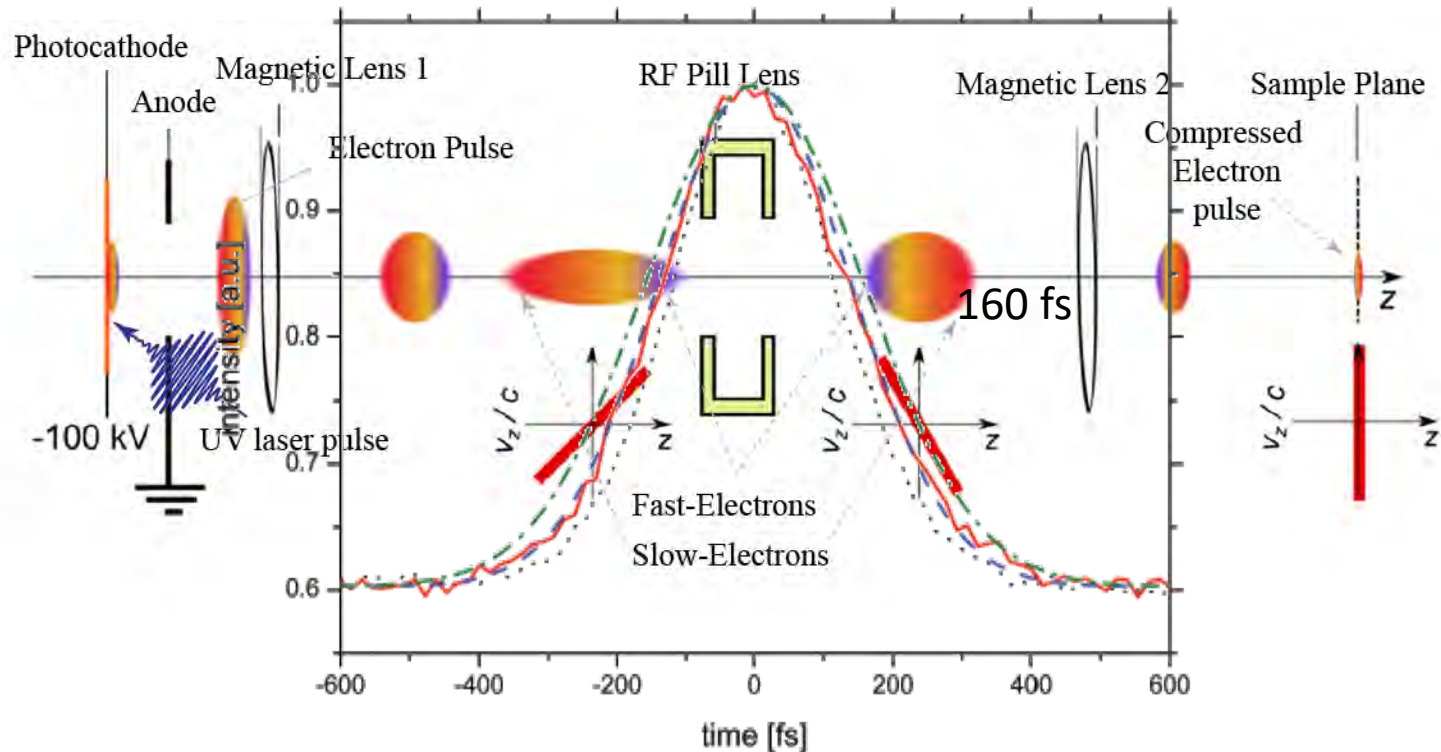

PRL 105, 264801 (2010)

Sciaini G and Miller R D 2011, Rep. Prog. Phys. 74 096101

M. T. Hassan, Attomicroscopy: from femtosecond to attosecond electron microscopy. *J. Phys. B: At. Mol. Opt. Phys.* 51, 032005 (2018).

Attomicroscopy Ultrafast Electron Diffraction applications

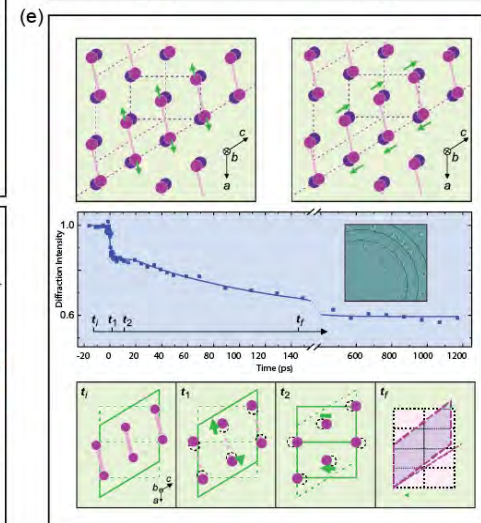
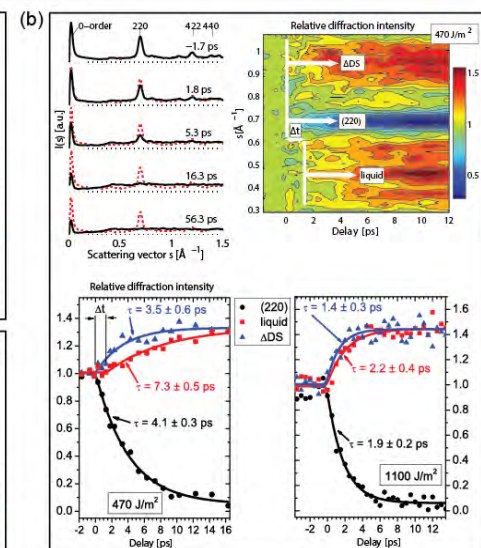
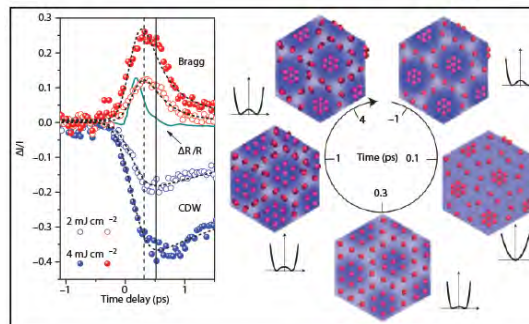
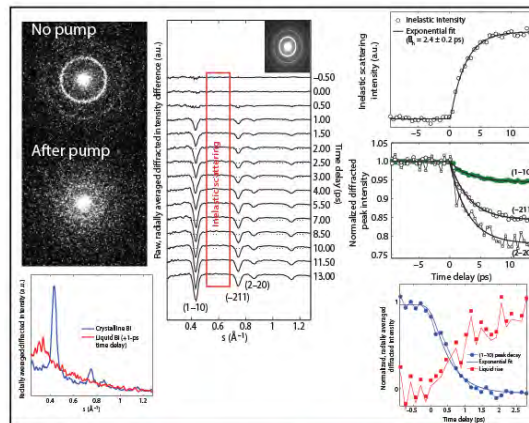
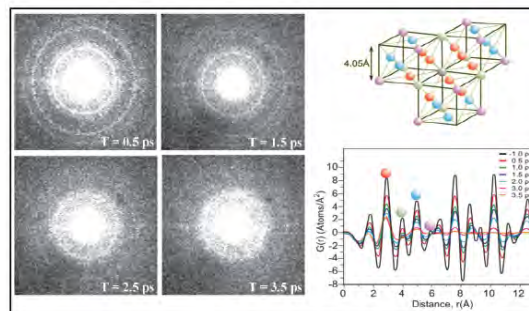
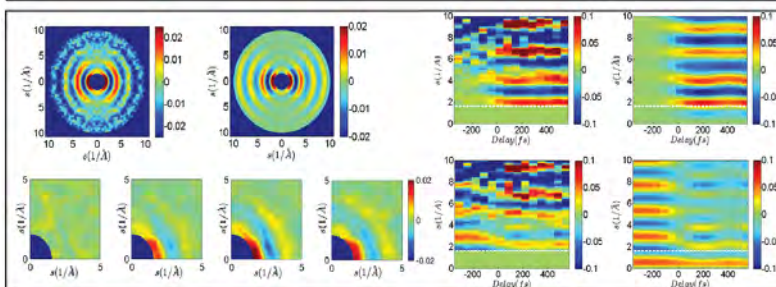
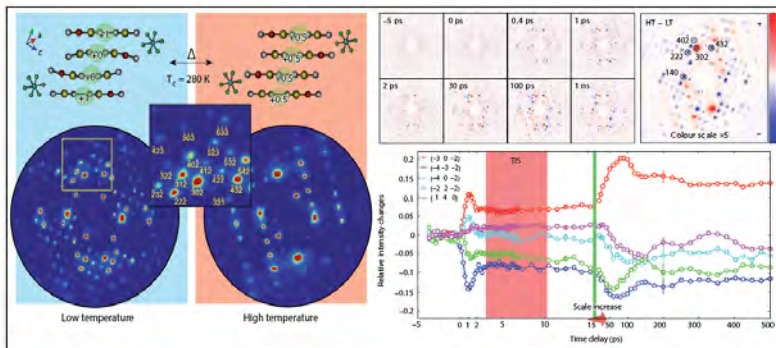
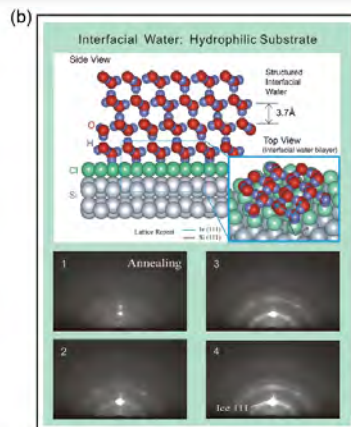
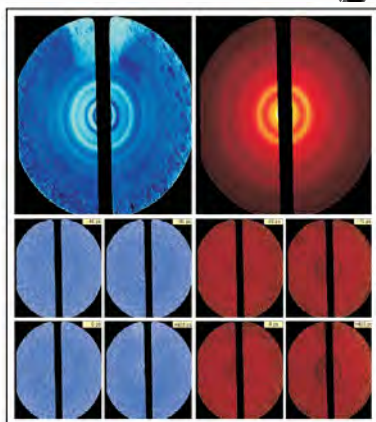

M. T. Hassan, Attomicroscopy: from femtosecond to attosecond electron microscopy. *J. Phys. B: At. Mol. Opt. Phys.* 51, 032005 (2018).

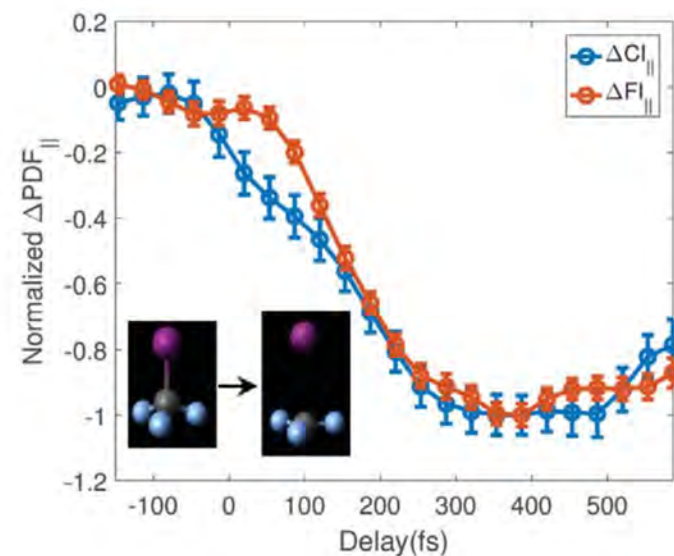
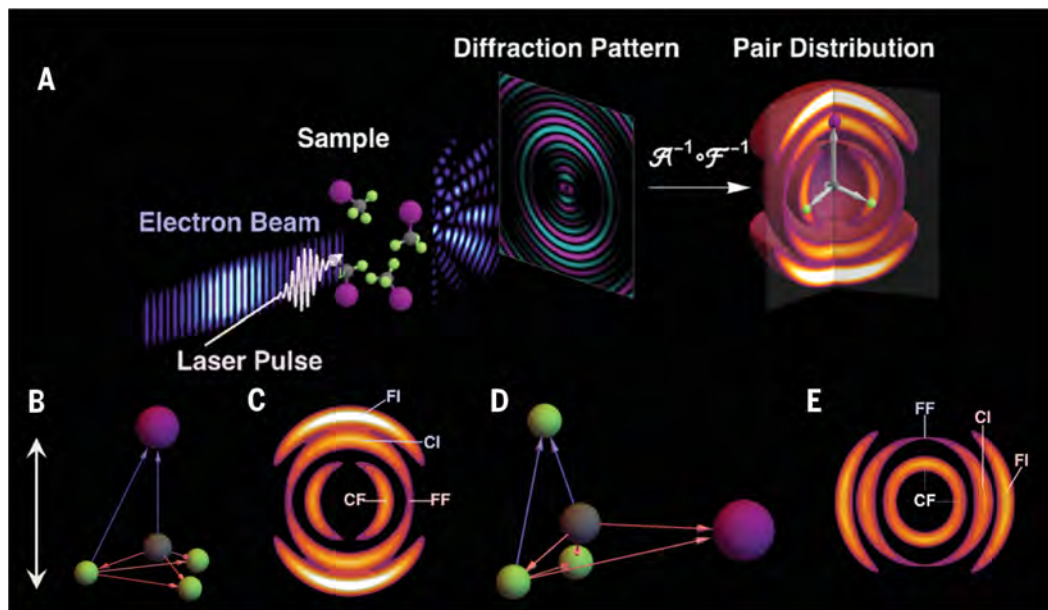
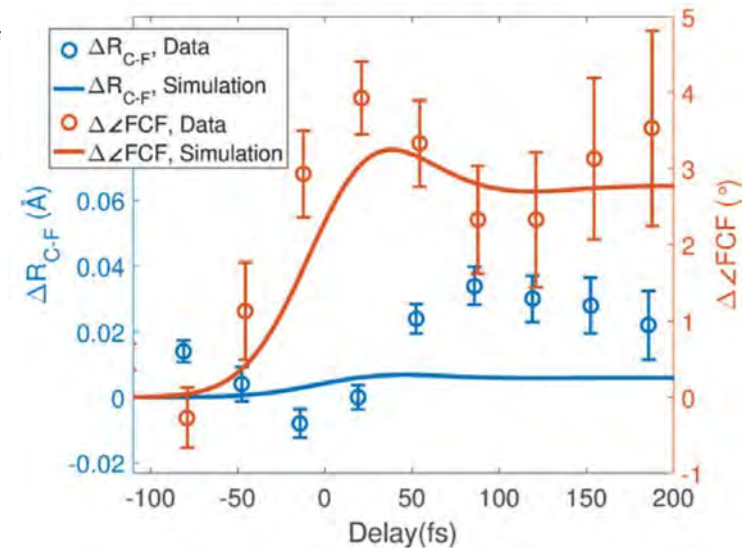
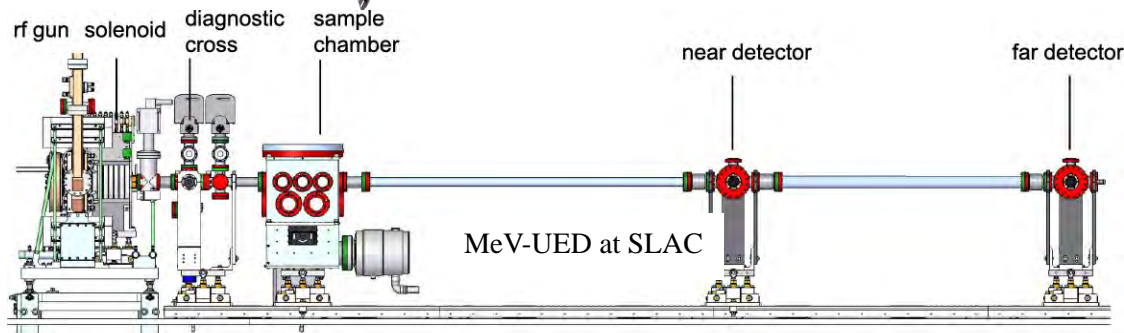

Jie Yang et. al. Science 361, 2020 (6397), 64-67.

Temporal resolution of Ultrafast Electron Diffraction & Microscopy

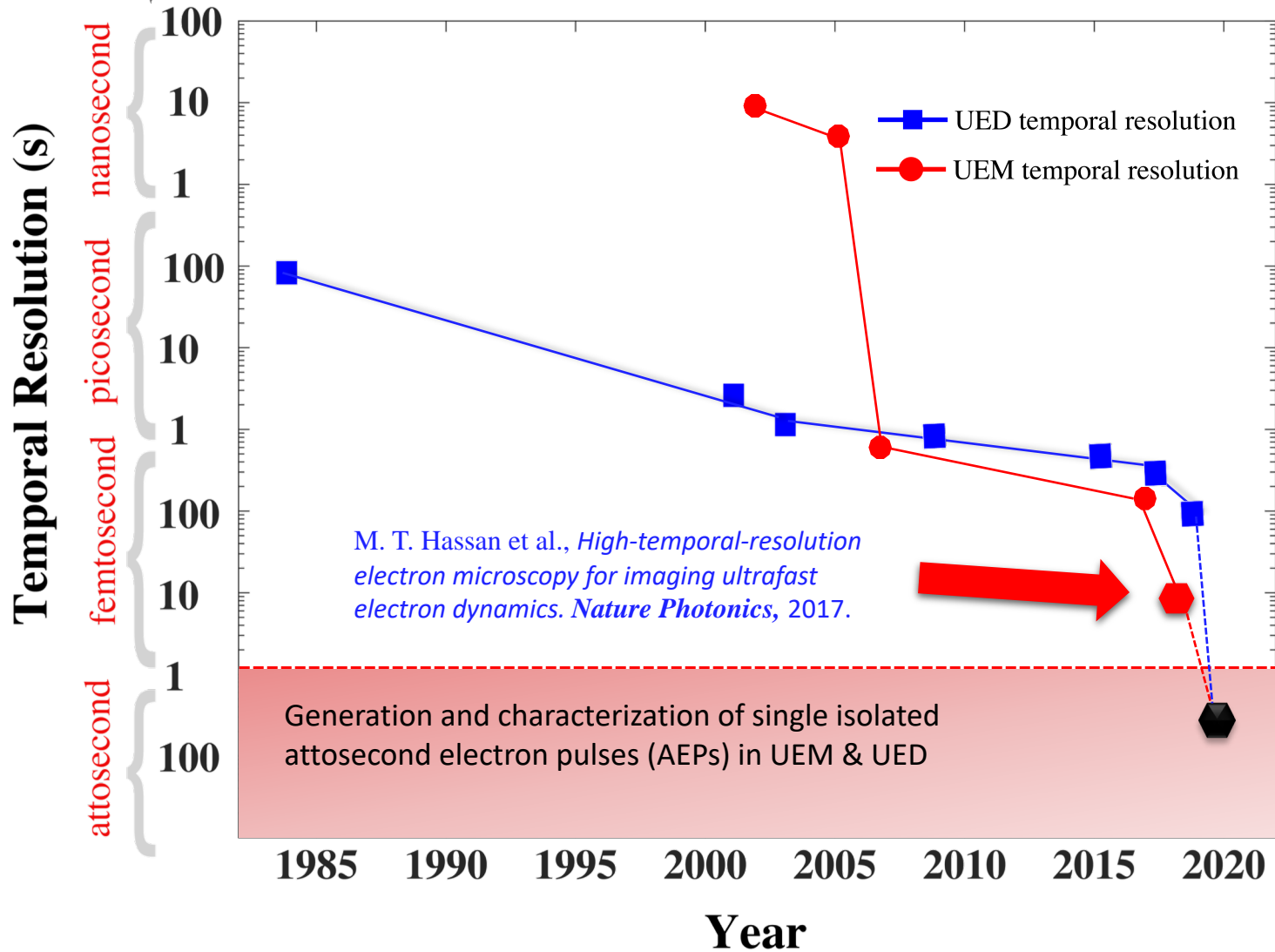

The road to the Attomicroscopy: Optical gating of free electron pulses

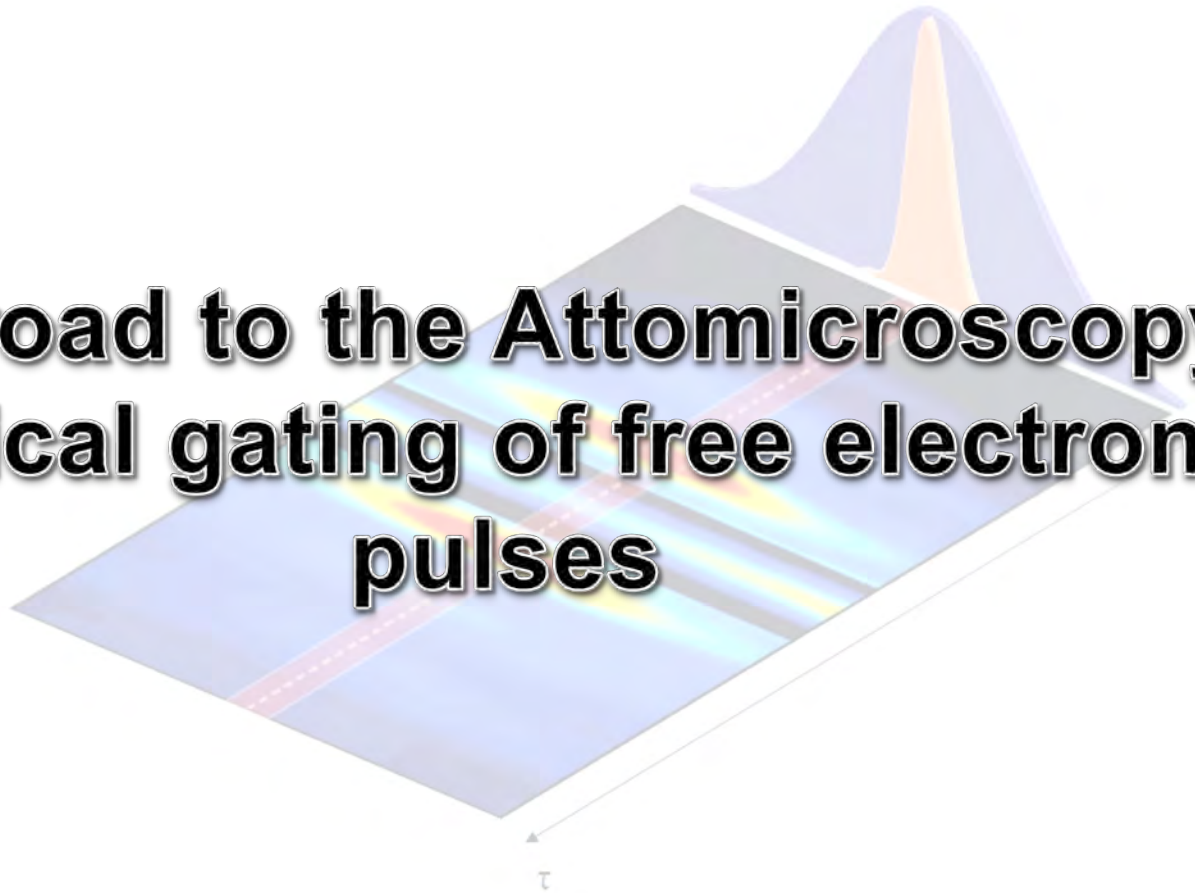

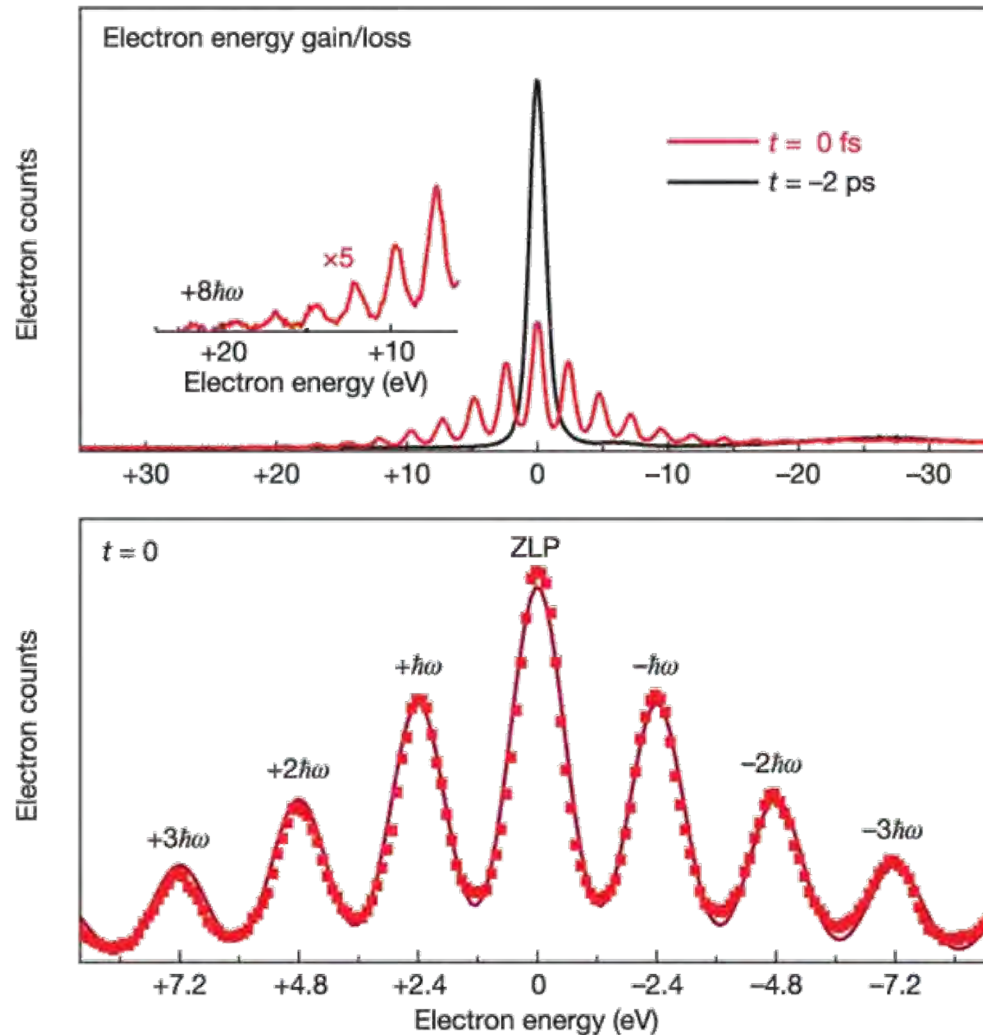

B. Barwick, D. J. Flannigan, A. H. Zewail, *Nature* 462, (2009).

Optical gating of ultrafast electron pulse

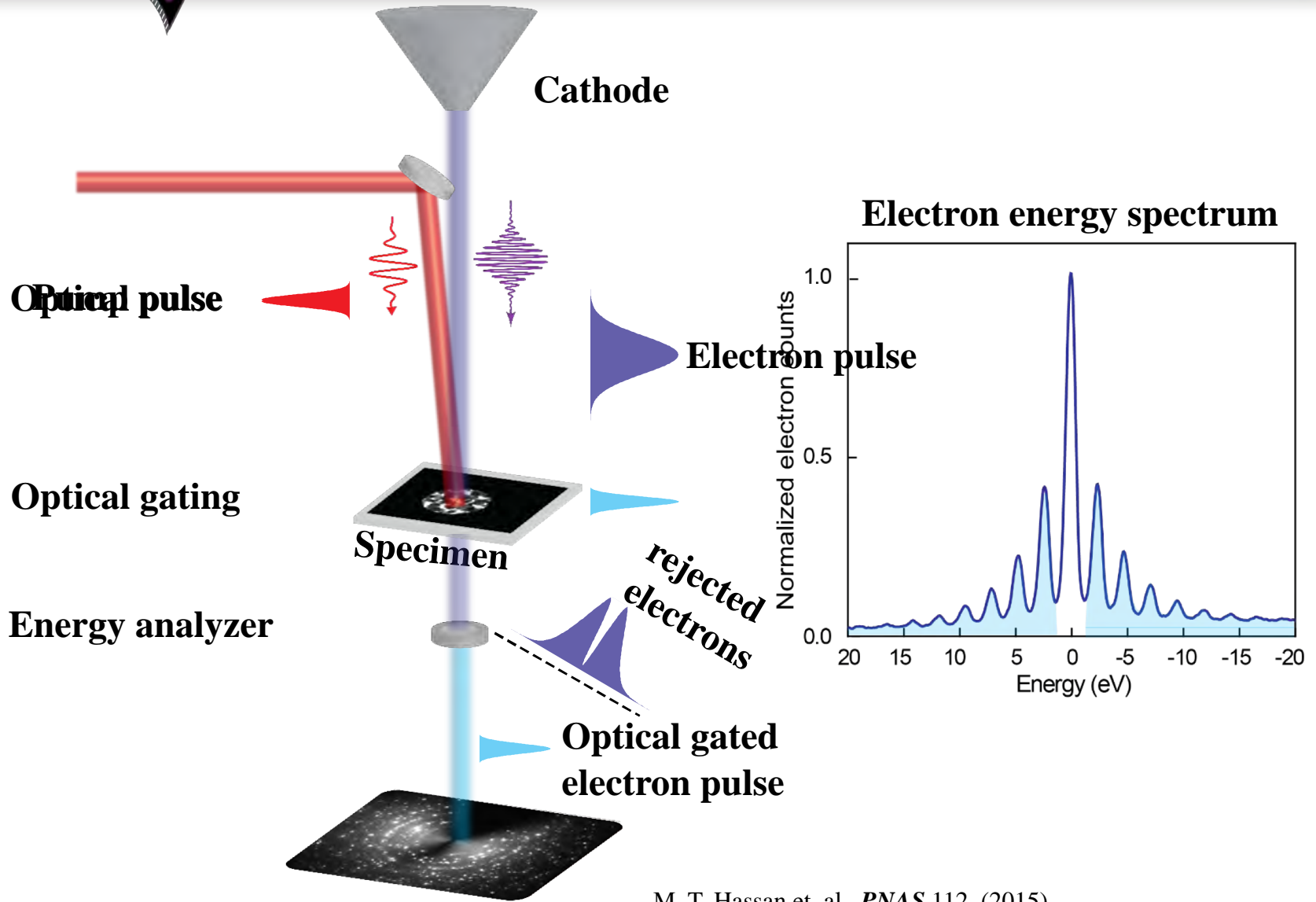

M. T. Hassan et. al., *PNAS* 112, (2015)

Optical gating experiment setup

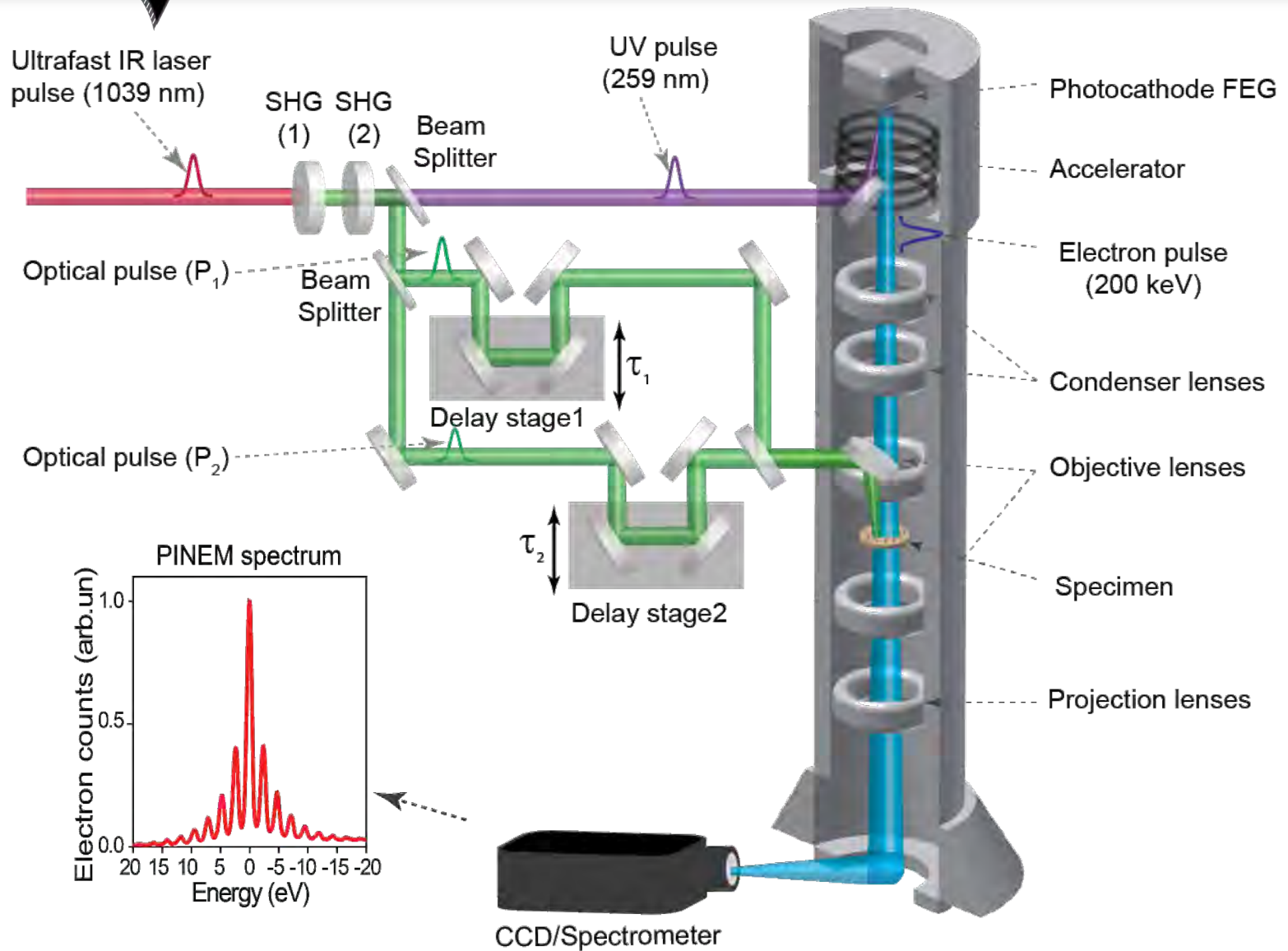

Optical gating of 200 fs electron pulse

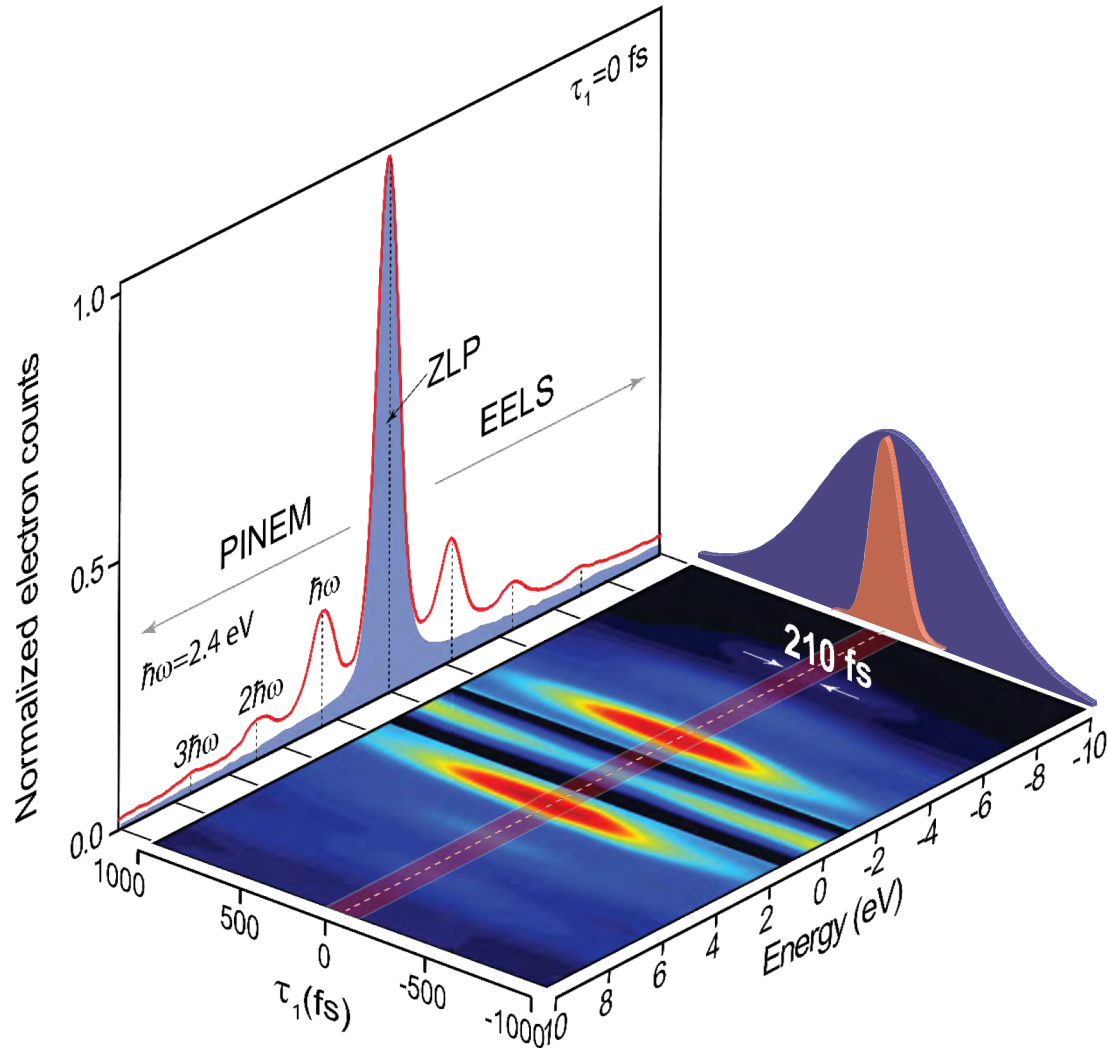

For a nanoparticles, the field integral at point (x,y) is given by

$$\tilde{F}_0 \approx -i\tilde{E}_0 \cos \phi \chi_s \frac{2}{3} a^3 (\Delta k)^2 K[\Delta kb]$$

\tilde{E}_0 the electric field amplitude of the incident light,
 ϕ the light polarization,
 a the radius of the cylinder,
 $b = \sqrt{x^2 + y^2}$ the impact parameter,
 Δk the momentum change of the electron,
 K the modified Bessel function of the second type, and

$$\chi_s = 3(\varepsilon - 1) / (\varepsilon + 2)$$

Where is χ_s and ε are the susceptibility and the dielectric constant of the material

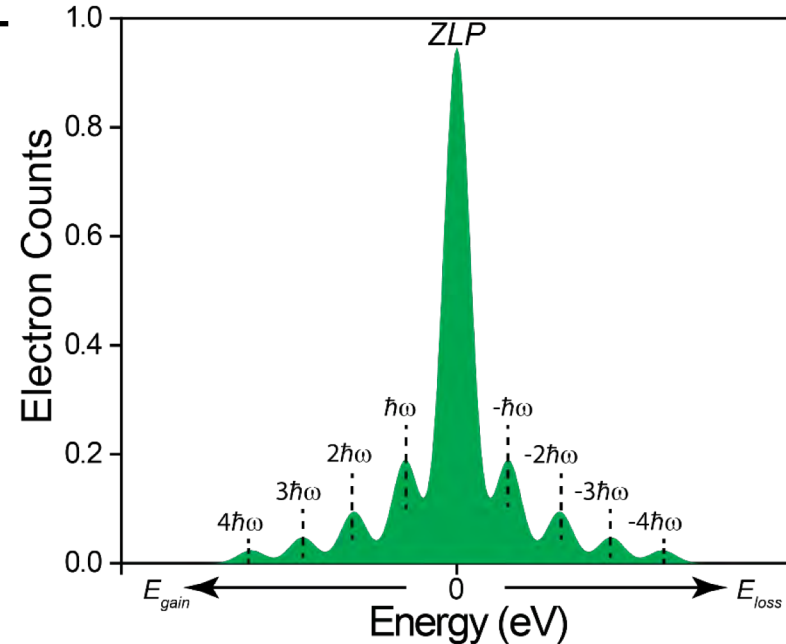

- B. Barwick, D. J. Flannigan, A. H. Zewail, *Nature* 462, (2009).
- S. T. Park, A. H. Zewail, *Physical Review A* 89, (2014).
- M. T. Hassan et. al., *PNAS* 112, (2015)

Ultrafast phase transition in VO₂ nanoparticle

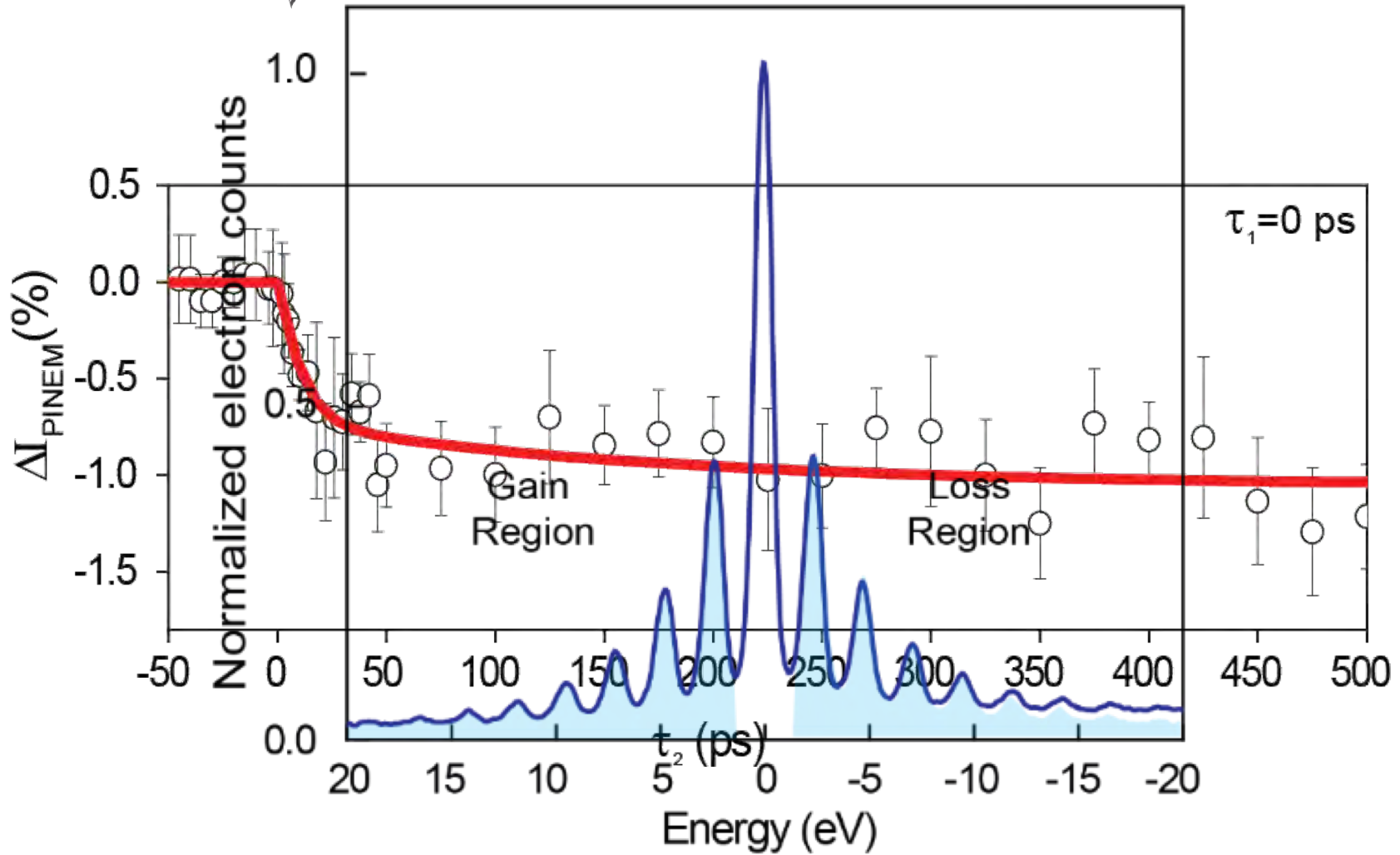

Ultrafast phase transition in VO₂ nanoparticle

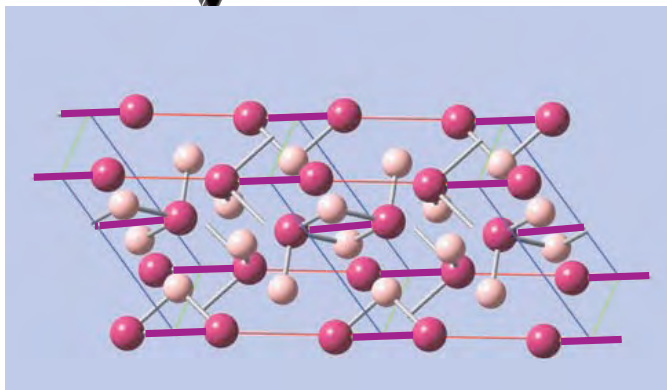

Monoclinic phase

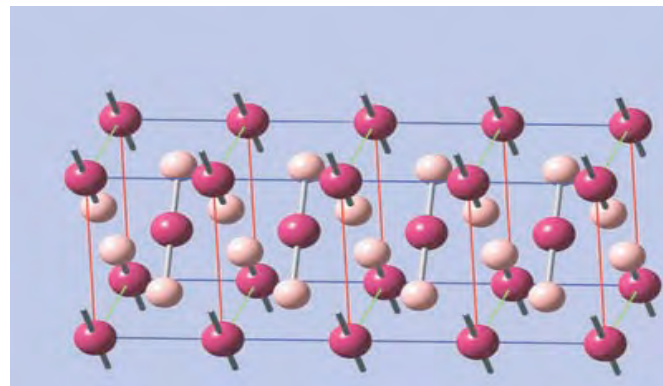

Tetragonal (rutile) phase

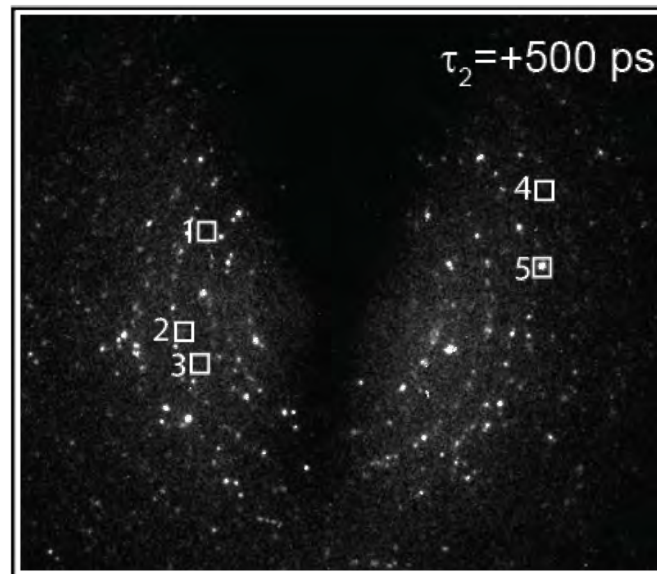
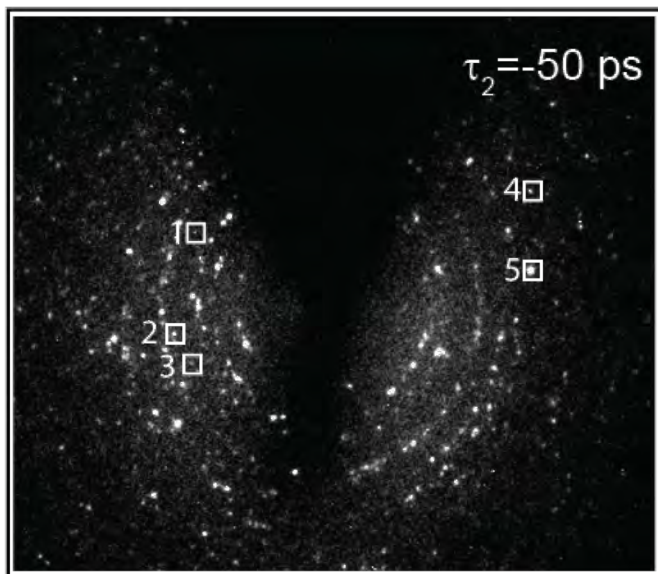

P. Baum et al., *Science* 318, (2007)788-792

M. T. Hassan et. al., *PNAS* 112, (2015)

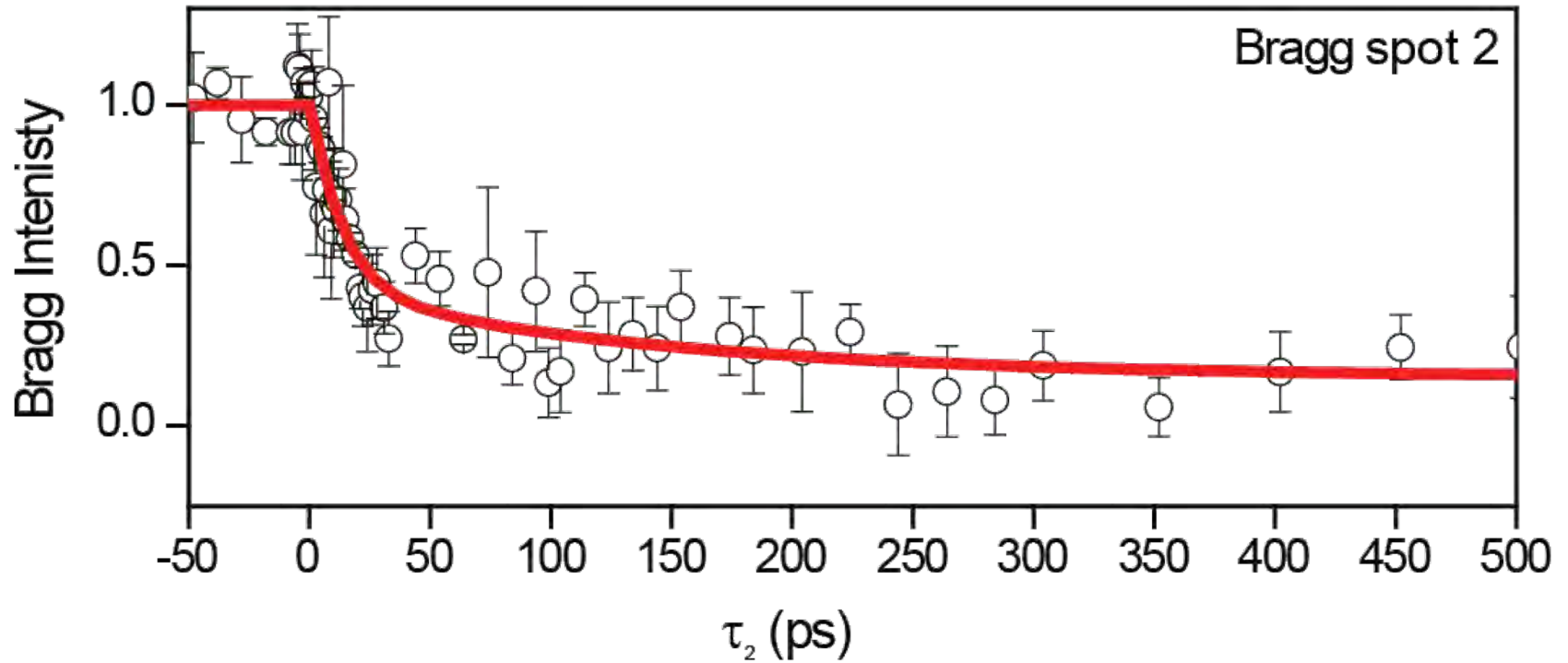

M. T. Hassan et. al., *PNAS* 112, (2015)

Realization of the electron dynamics temporal resolution in 4D Electron Microscopy

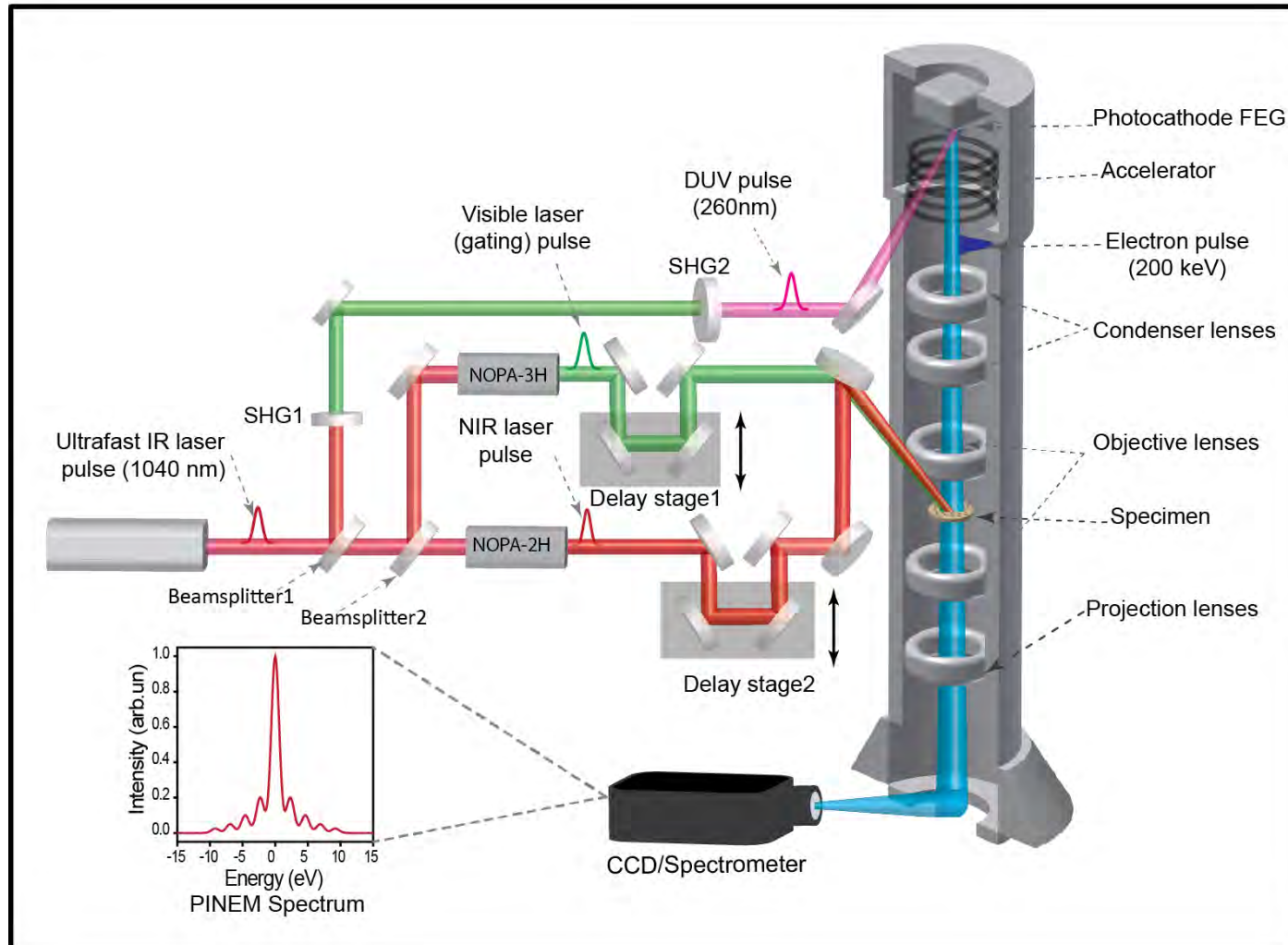

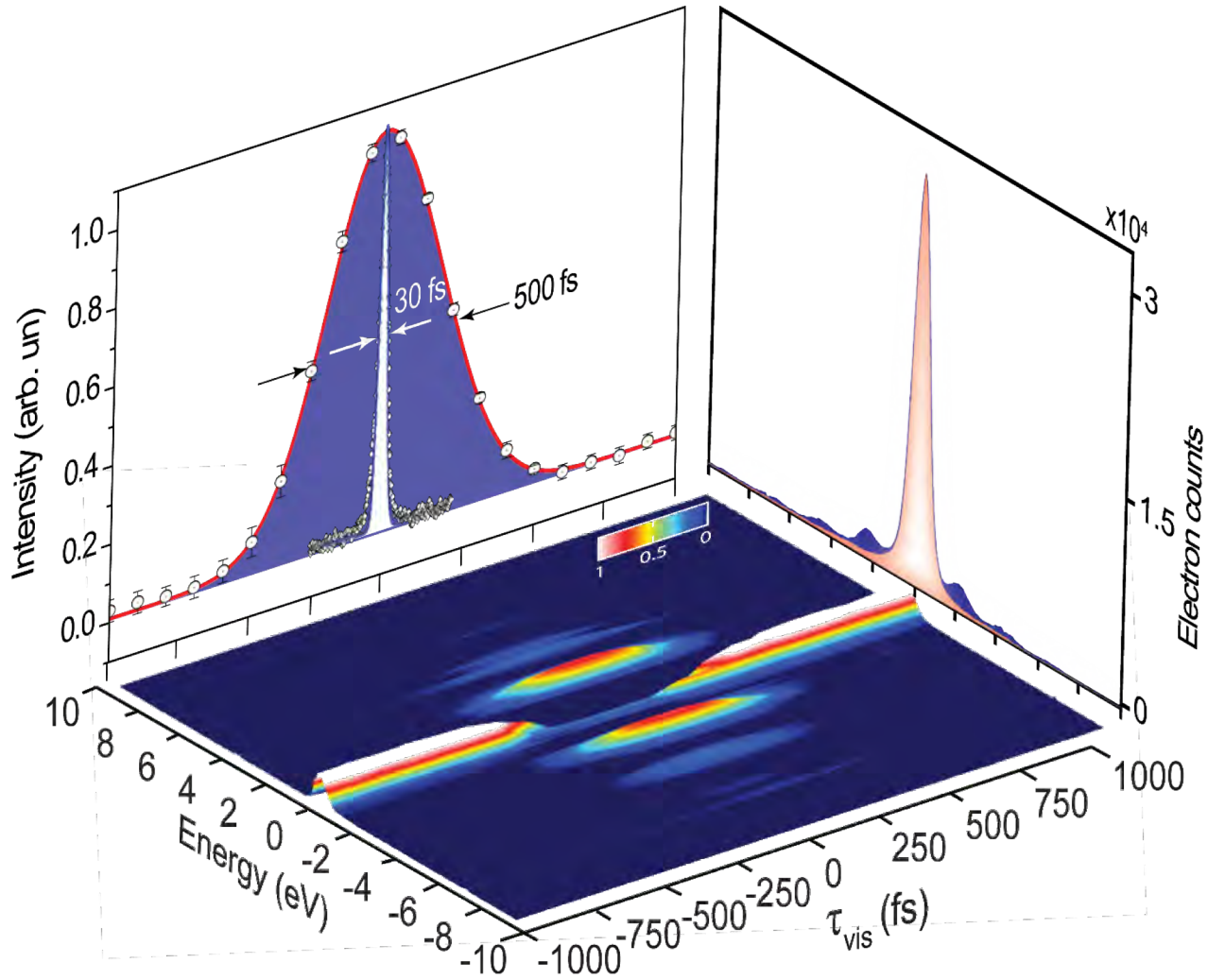

M. T. Hassan et al., *High-temporal-resolution electron microscopy for imaging ultrafast electron dynamics. Nature Photonics*, 2017. **11**(7): p. 425-430

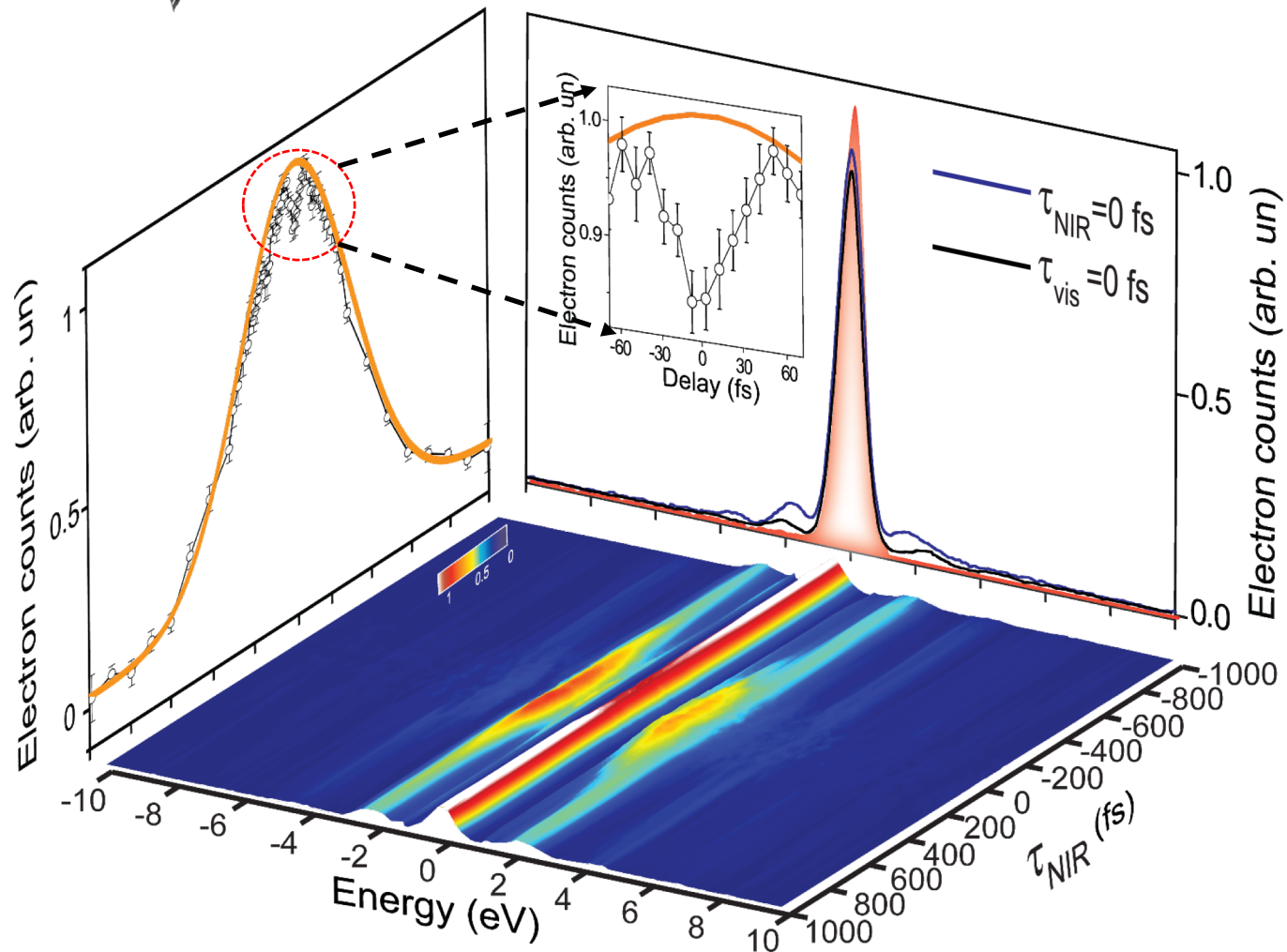

M. T. Hassan et al., *High-temporal-resolution electron microscopy for imaging ultrafast electron dynamics*. *Nature Photonics*, 2017. **11**(7): p. 425-430

Realization of the electron-motion temporal resolution in 4D Electron Microscopy

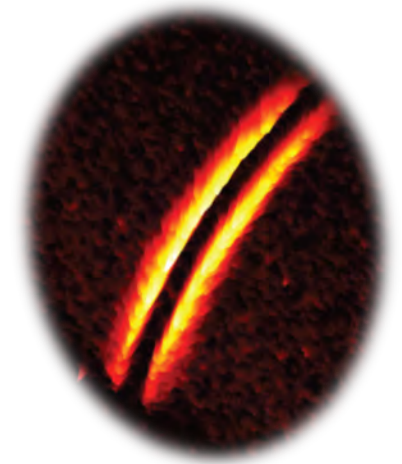
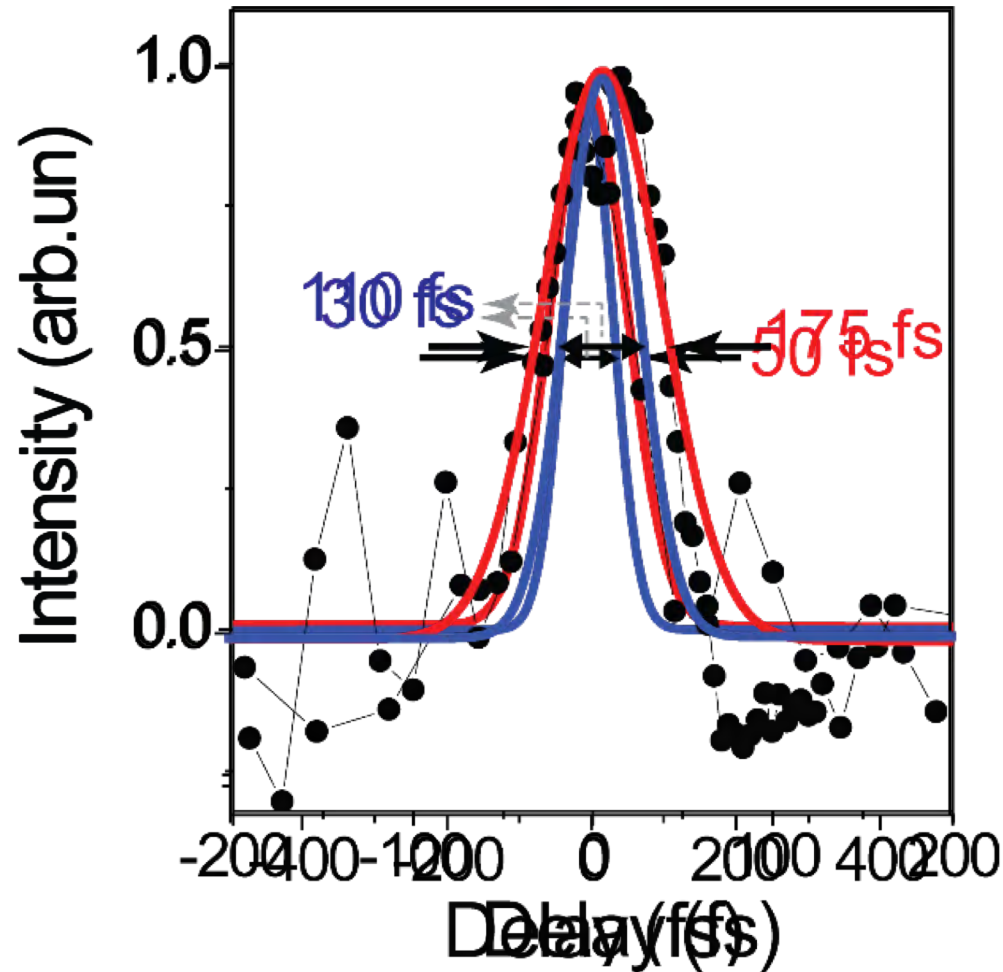

M. T. Hassan et al., *High-temporal-resolution electron microscopy for imaging ultrafast electron dynamics*. *Nature Photonics*, 2017. **11**(7): p. 425-430

M. Th. Hassan et al., *Nature*, 2016. **530** (7588)

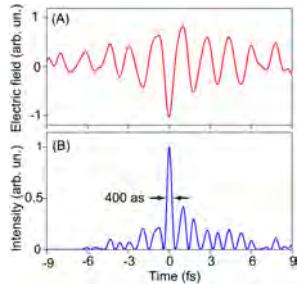

Optical attosecond pulse

Attosecond optical gating

- Single isolated attosecond electron pulses
- Attosecond pump pulses
- Attosecond phase stability and imaging stability

M. T. Hassan et al., *High-temporal-resolution electron microscopy for imaging ultrafast electron dynamics. Nature Photonics*, 2017. **11**(7): p. 425-430

M. T. Hassan, Attomicroscopy: from femtosecond to attosecond electron microscopy. *J. Phys. B: At. Mol. Opt. Phys.* **51**, 032005 (2018).

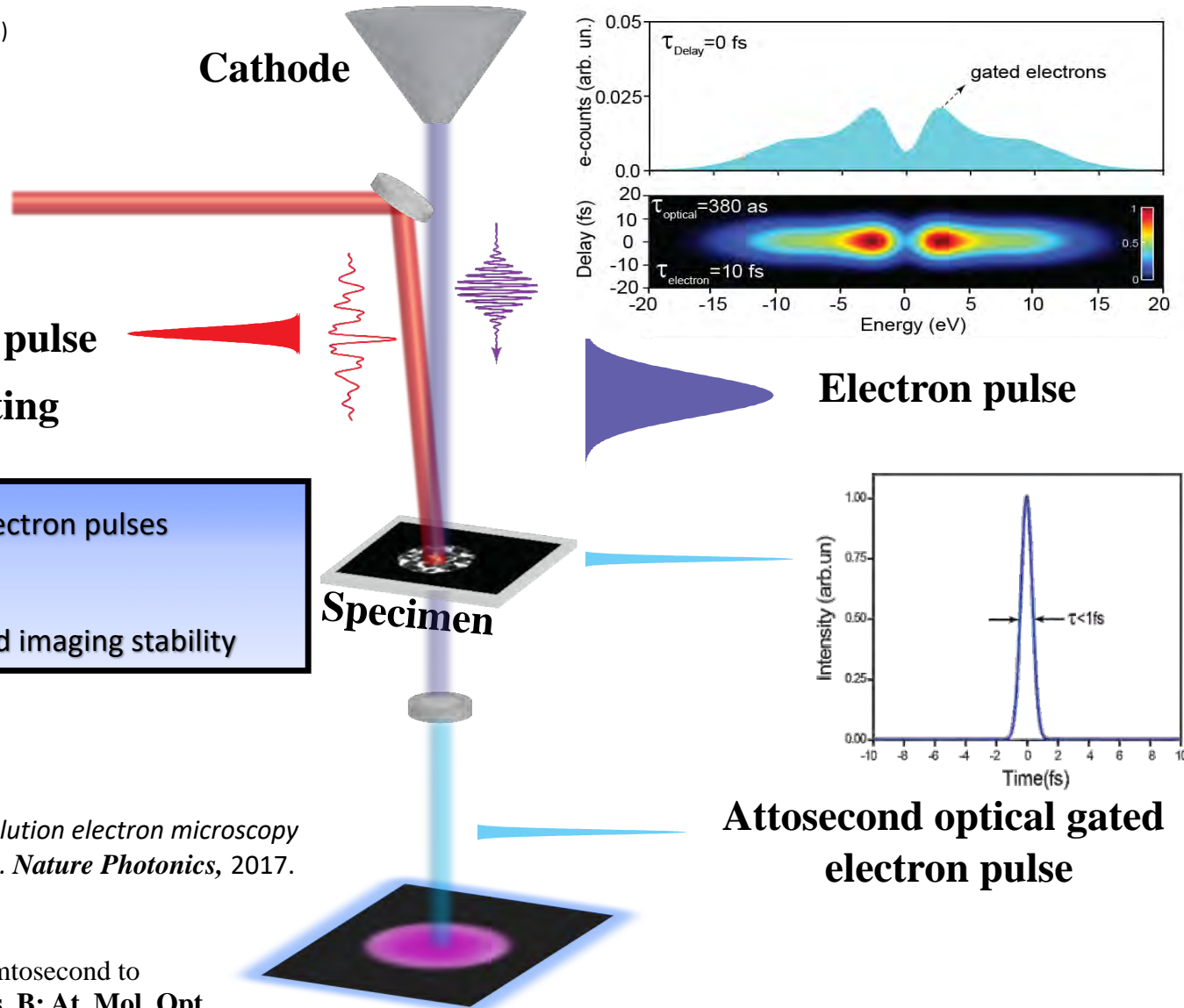

Attomicroscopy setup

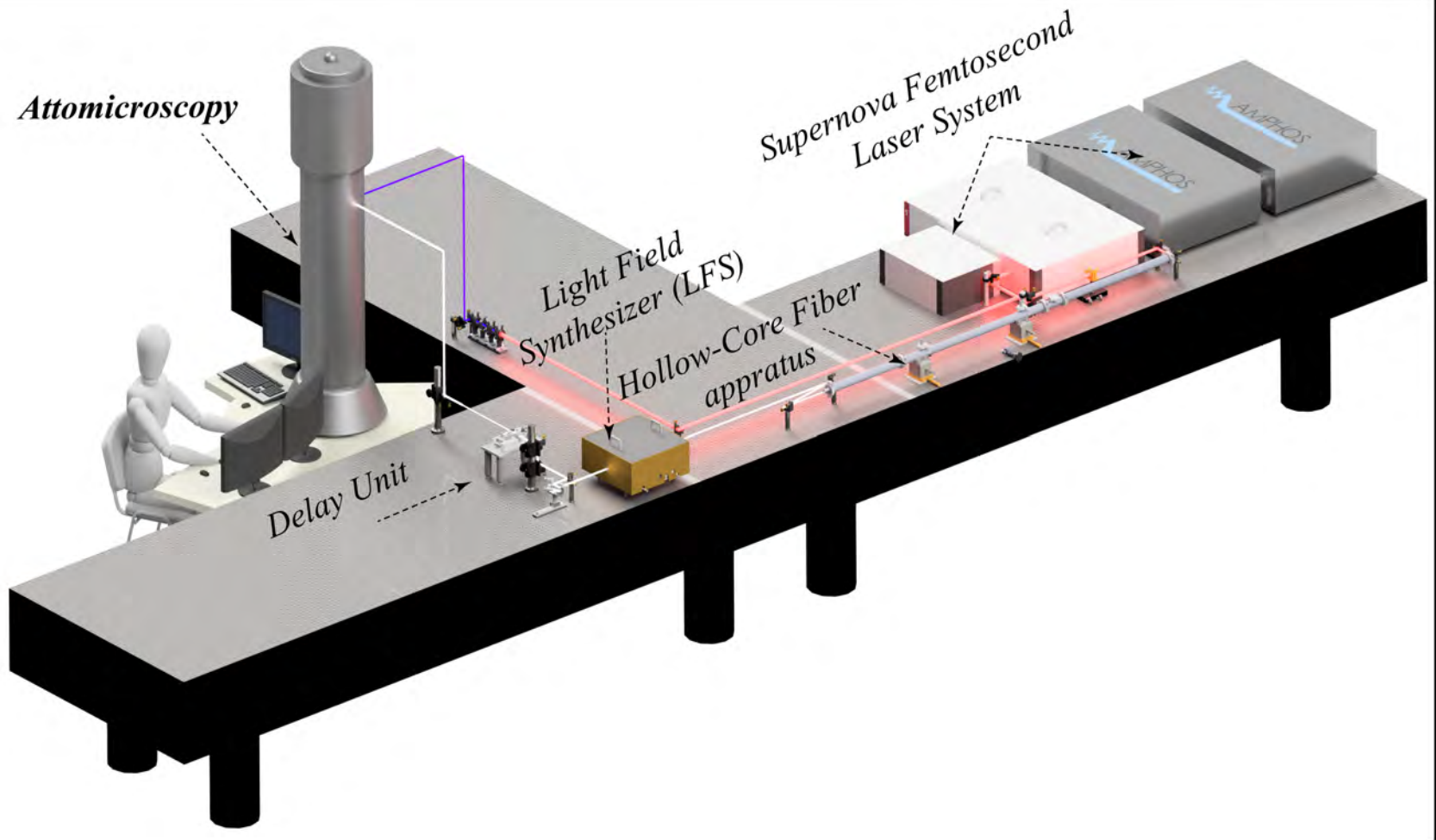

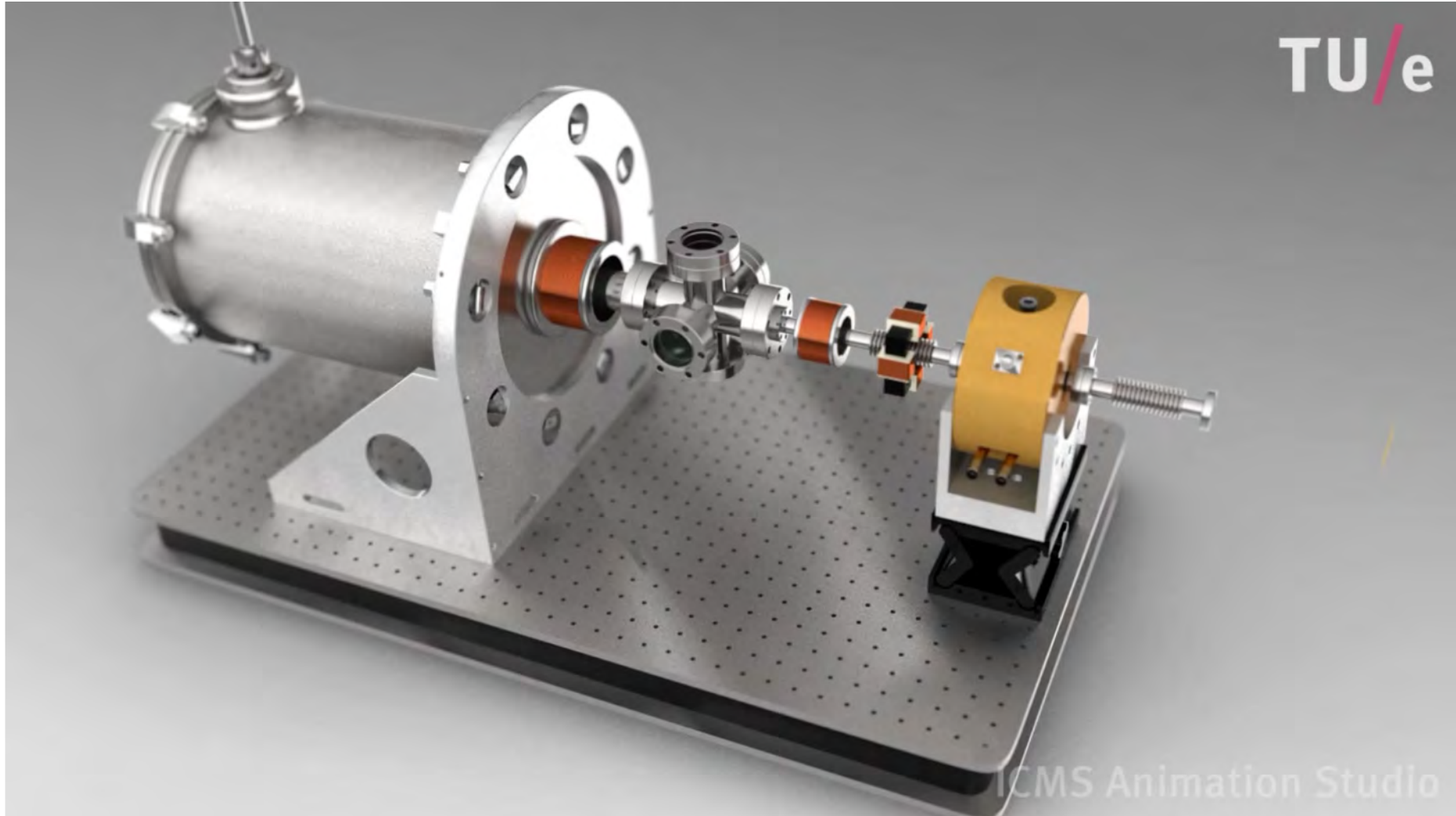

ICMS Animation Studio

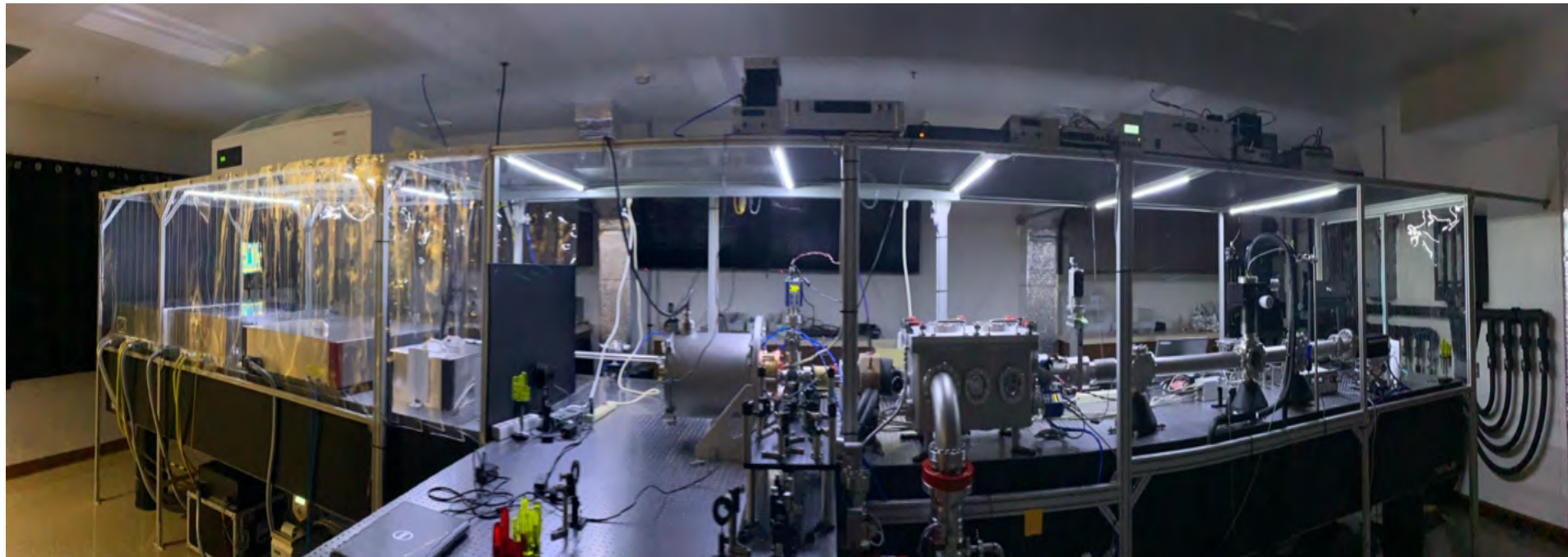

Electron beam properties

$E = 90 \text{ KeV}$,

The number of electrons $= 10^9 / S$

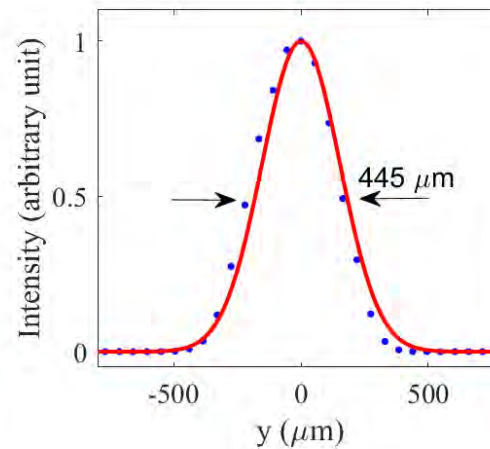
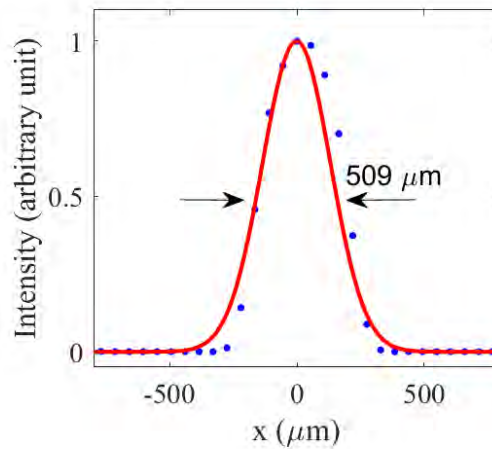
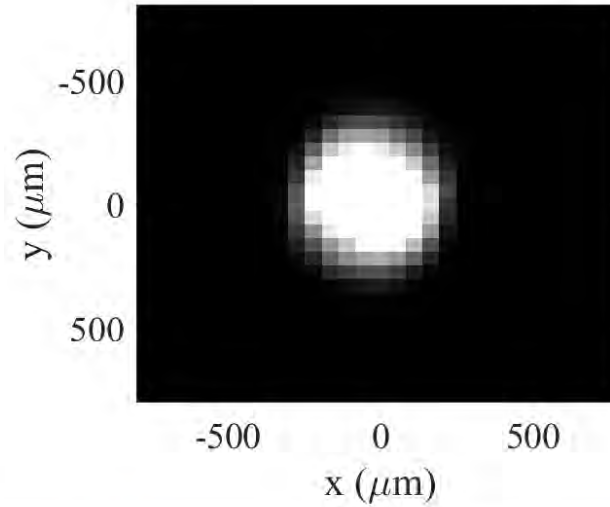

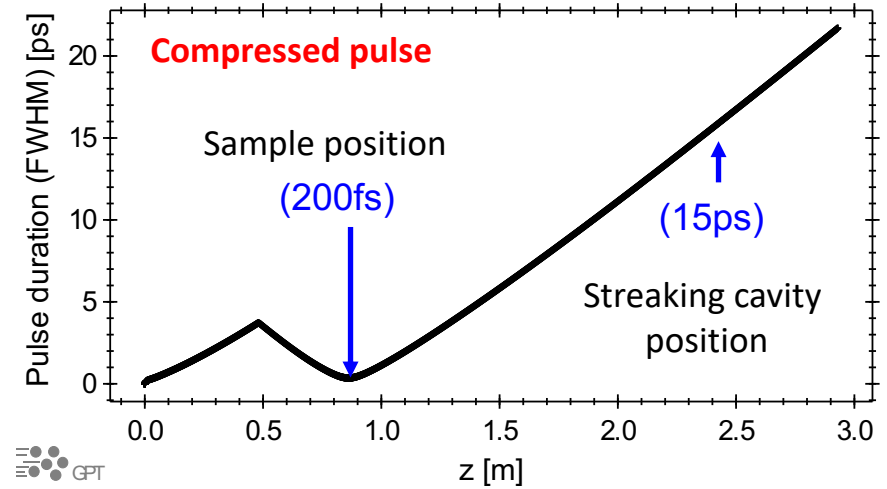
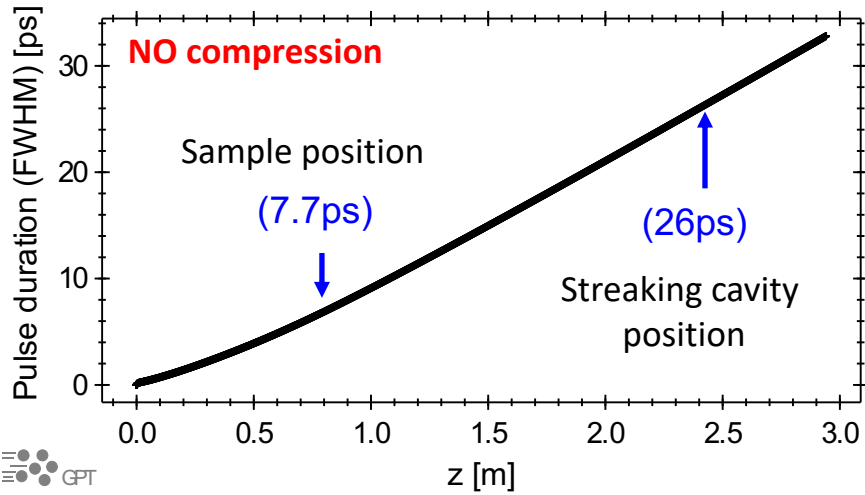
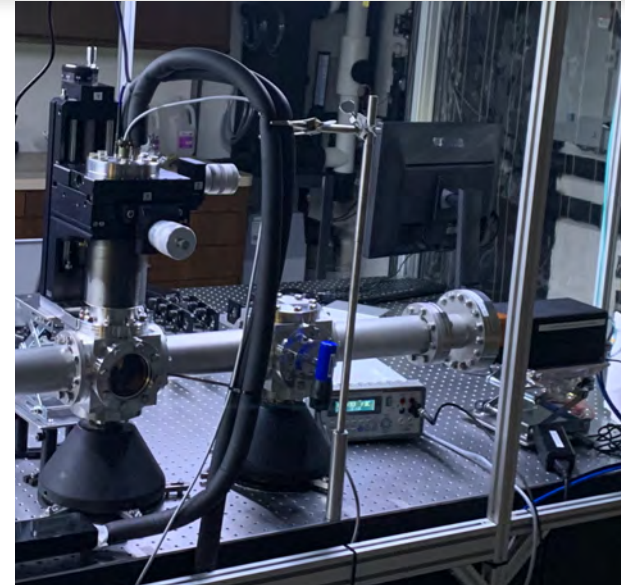
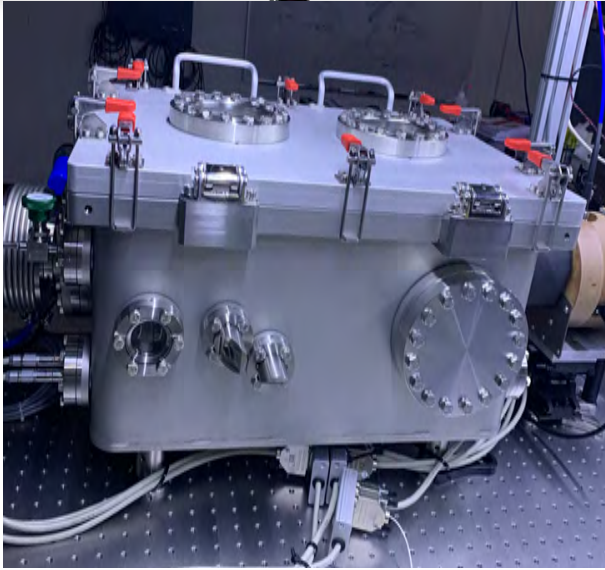

Direct imaging resolution

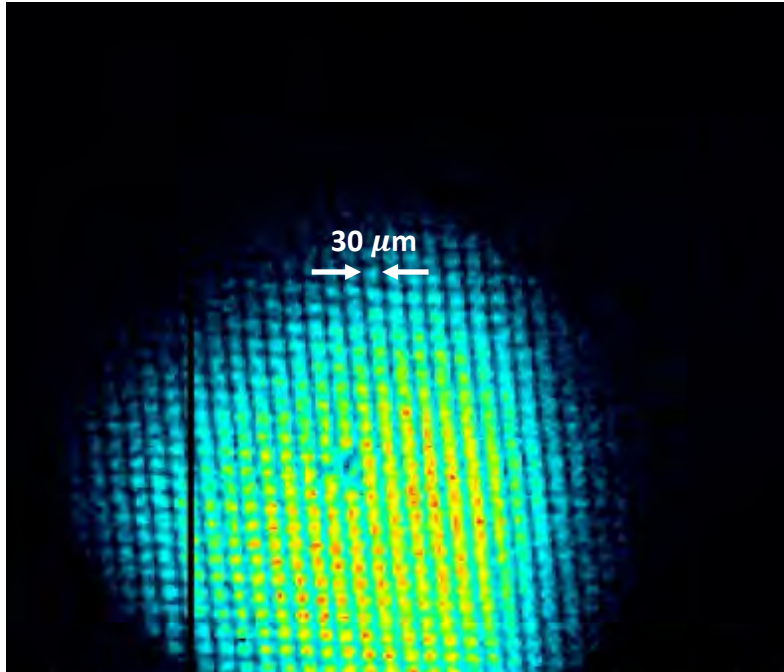

Direct Imaging of Aluminum grid
Resolution <math>< 30 \mu\text{m}</math>

Diffraction imaging resolution

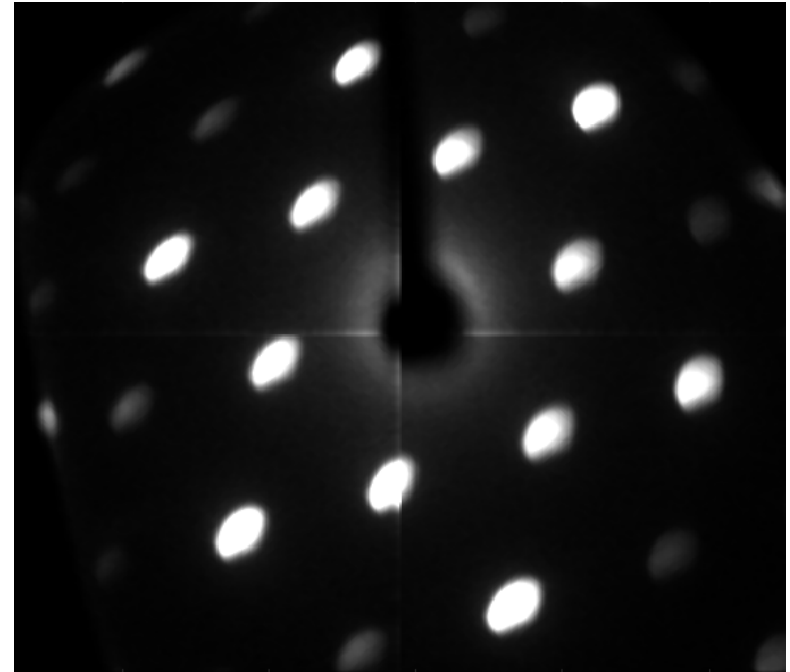

Diffraction pattern of graphene
Resolution = 1 Pm

gating attosecond laser pulse

gated attosecond electron pulse

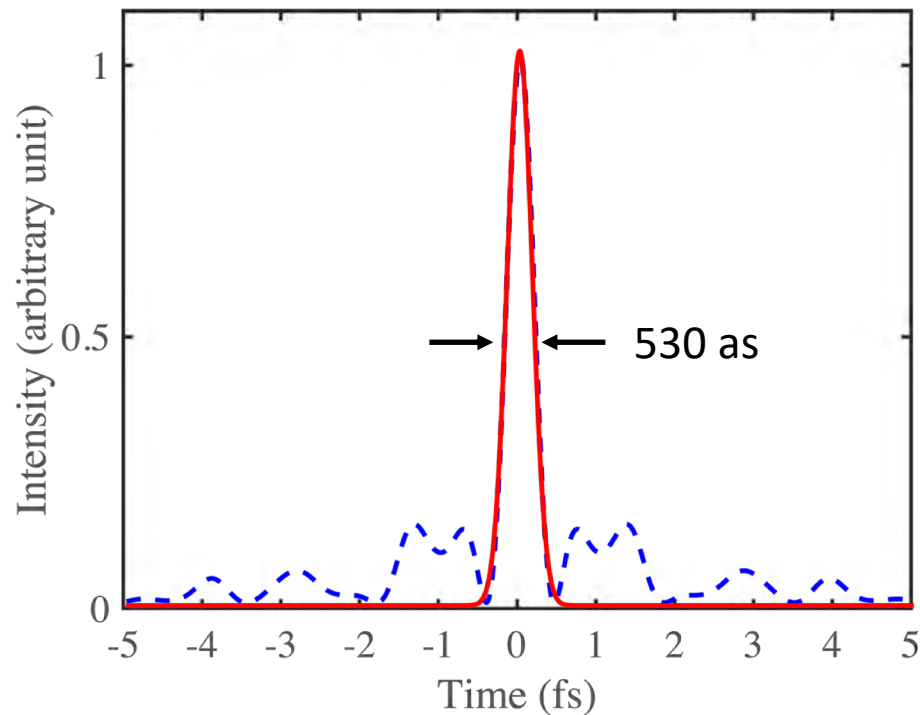

Attomicroscopy will be the Rosetta Stone for electron dynamics in complex and quantum systems

Science:

- Imaging electron motion to reveal the quantum physics of complicated systems—impossible to simulate even when using quantum computers
- Snapshots of electron motion to provide real-time access to electron dynamics and improve our understanding of chemical interactions
- The recent developments in Cryo-electron microscopy (Nobel prize-2017) and the liquid-cell technology in electron microscopy together with Attomicroscopy will enable studies of electron dynamics in biomolecules in their native environment

Information technology:

- Imaging electron dynamics in the solid-state in both real time and space.

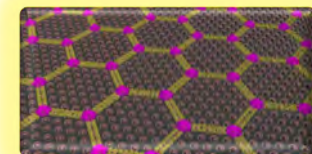
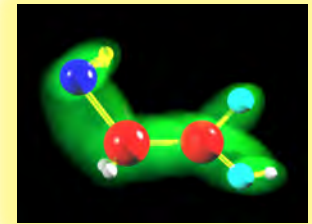

Postdoctoral scholars

Dandan Hui

Farhad Afkhami

PhD students

Husian Alqattan

Collaborators

- **LMU/MPQ**
Vladimir Pervak
- **Center for Computational Sciences
University of Tsukuba**
Kazuhiro Yabana
Shunsuke Yamada

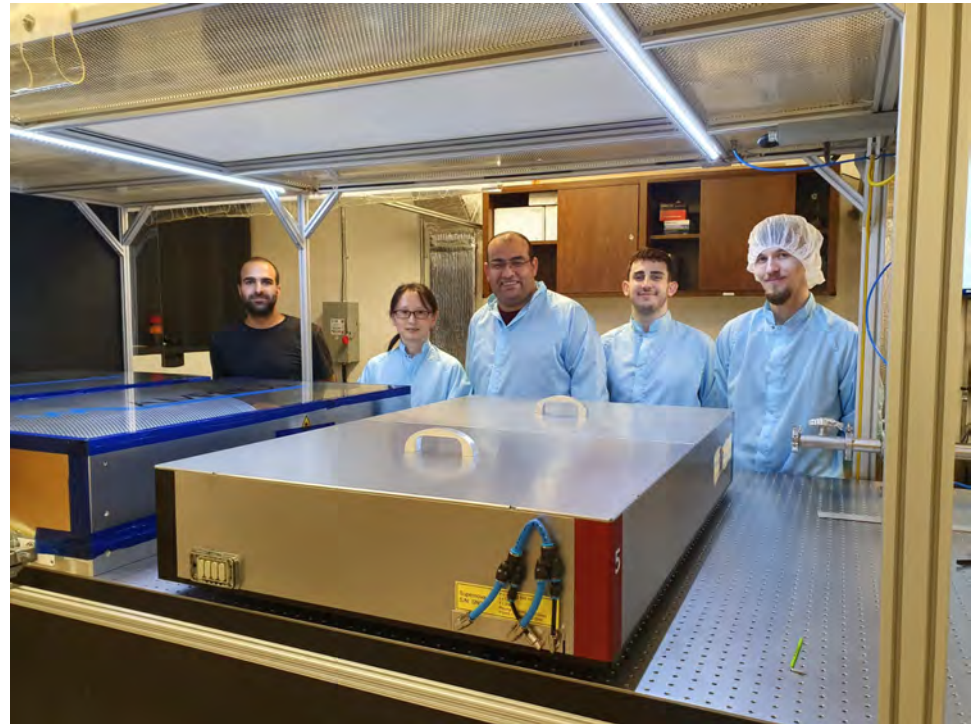

GORDON AND BETTY
MOORE
FOUNDATION



Open positions:

- Postdoc position
- Research Scientist Position

Mohammed Hassan

mohammedhassan@email.arizona.edu

or visit our webpage www.Hassan.lab.arizona.edu

